

**Cobot Transfer Unit  
for UR cobots**

*User manual for the Partly Completed Machinery*





# Content

<b>1 Warnings and legal notes</b>	UM-3
Residual risks, Iso 9001:2015, Warranty conditions	UM-4
Environmental indications, Safety warnings for handling and transport	UM-5
Packaging, Transport	UM-6
Handling and lifting, Check axis integrity after shipment, Installation	UM-7
<b>2 CTU - basic components</b>	
What's included, Robot compatibility	UM-8
<b>3 Specific system references</b>	UM-9
<b>4 Installation instructions</b>	
Handling CTU, Sensors	UM-11
Installing CTU	UM-12
Mounting the robot on CTU	UM-13
Connecting CTU	UM-14
Connecting the robot	UM-16
Air connection, Carriage blocking element (optional)	UM-17
Notes on lubrication	UM-18
<b>5 Rollon URCap manual (e-Serie)</b>	
Rollon URCap Installation	UM-19
Drive configuration	UM-21
IP connection	UM-22
Manual positioning of the axis	UM-23
Polyscope programming	UM-24
Errors	UM-27
Support	UM-29
<b>6 Rollon URCap manual (CB-Serie)</b>	
Rollon URCap Installation	UM-30
Drive configuration	UM-32
IP connection	UM-33
Manual positioning of the axis	UM-34
Polyscope programming	UM-35
Errors	UM-39
Support	UM-41

## Annexes:

- Manual of the motor
- Manual of Rollon electrical cabinet

## Warnings and legal notes



The Partly Completed Machinery shown in this manual is to be considered a mere supply of simple Cartesian axes and their accessories agreed when the contract is stipulated with the client.

The following are therefore to be considered excluded from the contract:

1. Assembly on the client's premises (direct or final)
2. Commissioning on the client's premises (direct or final)
3. Testing on the client's premises (direct or final)

It is therefore understood that the aforementioned operations in points 1., 2., and 3. are not chargeable to Rollon. Rollon supplies Partly Completed Machinery. The client (direct or final) is responsible for testing and verifying that the equipment is safe, which by definition cannot be theoretically verified or tested at our premises. The partly completed machine must not be commissioned until the final machine, in which it is to be incorporated, has been declared compliant, if necessary, with the instructions in Machinery Directive 2006/42/CE.

This 7th axis is not a "collaborative" equipment.



It is mandatory to carefully consult this manual prior to incorporating the Partly Completed Machinery. The information contained in the following manual is for highly qualified and certified personnel, possessing adequate competence in incorporating the partly completed machinery.



The manufacturer cannot be considered responsible for any consequences derived from improper use or any use other than the purpose the system was designed for, or derived from failure to comply, during incorporation phases, with the rules of Good Technique and with what is indicated in this manual.



Do not overload. Do not subject to bending forces.



To avoid damage, do not work on this machinery with unsuitable tools.



Do not leave exposed to weather.



Warning: moving parts. Do not leave objects on the axis.



Before handling, stabilize the axis by securely blocking its mobile parts. When handling axes with vertical translation, it is mandatory to make sure the carriage is at the corresponding lower limit switch.



**Make sure** that the system is installed on a level floor surface.



During use, **carefully comply with** the specific performance values stated in the catalog



Precaution in installation and handling operations. Significantly heavy equipment.



When handling the actuator, always make sure that the support or anchoring surfaces do not leave room for bending.



The images in this manual are to be considered **merely an indication and not binding**; therefore, the supply received could be different from the images contained in this manual, and Rollon S.p.A has deemed it useful to insert only one example.



Motor and gearbox generate heat during operation. Do not touch the motor/gearbox while in operation or immediately after operation, as prolonged contact can cause discomfort. Cool the motor/gearbox by powering off the system and wait.



Hazardous voltage.  
Turn power off before commissioning or servicing.



Make sure all electrical parts remain dry. In case of contact with water, switch the power off immediately.



Systems supplied by Rollon S.p.A. are not designed/envisaged to operate in ATEX environments.



Prevent dust from entering the electrical cabinet.

## > Residual risks

The linear axis has the following residual risks:

- Mechanical risks due to the presence of moving elements;
- Risk of fire resulting from the flammability of the belts used on the axes, for temperatures more than 250 °C in contact with the flame;
- The risk of the vertical axis dropping during handling and installation operations on the partly completed machinery, before commissioning;
- Risk of the vertical axis dropping during maintenance operations in the case of a drop in the electrical power supply voltage;
- Crushing hazard near moving parts with divergent and convergent motion;
- Cutting and abrasion hazards.

## > Warranty conditions

Rollon S.p.A. provides the following warranty pursuant to art. 1512 of the Italian Civil Code: the proper function of its products for the period of one year from their delivery, when their concrete application is suggested by the Technical or Commercial Office of our company and as long as any reports of malfunction are submitted in writing within eight days from their discovery. This warranty does not cover damage or defects due to external agents, insufficient maintenance, overloading, use of improper lubricant, natural use, inexact product choice, assembly errors or other causes attributable to improper use and not attributable to the manufacturing of the product.

The warranty is limited to repair and/or replacement, excluding claims for further damages.

## > ISO 9001:2015

Rollon S.p.A. is certified ISO 9001:2015.

Starting in 1995, Rollon has defined and built its own quality management system to ensure that Client expectations and needs are satisfied, conformity with standards and contractual specifications are guaranteed, and efficient management of its corporate activities is achieved.

Within this scope, the as in this sense, Rollon has identified its management and production processes, and designed the sequences and interactions, criteria and control methods to include and implement, analyses and measurements to record, and the actions that may be necessary to obtain the expected results.

## > Environmental indications

Environmental protection is very important for Rollon, and therefore its operations are done with the goal of limiting environmental impact. The indications listed below are to ensure correct management of our supply.

Our products are mainly composed of:

Material	Details of the supply
Aluminum alloys	Profiles, plates, various details
Steel with various compositions	Screws, and rails
Plastic	PAG - Chains PVC - Covers and sliding block scrapers
Rubber of various types	Plugs, seals
Lubrication of various types	Used for the lubrication of sliding rails and bearings
Rust proof protection	Rust proof protection oil
Wood, polyethylene, cardboard	Transport packaging

Tab. 1

At the end of the product's life cycle, it is therefore possible to recover the various elements, in compliance with current regulations on waste issues.



### IMPORTANT!

The machine rails are protected with a layer of rust-proof oil or specific grease. Use suitable gloves when handling.

## > Safety warnings for handling and transport

- The manufacturer has paid the utmost attention to packaging to minimize risks related to shipping, handling and transport.
- Transport can be facilitated by shipping certain components dismantled and appropriately protected and packaged.
- Handling (loading and unloading) must be carried out in compliance with information directly provided in this user manual.

- Personnel authorized to lift and handle the machine and its components must possess acquired and acknowledged skills and experience in the specific sector, besides having full control of the lifting devices used.
- Handling and transport must be carried out with vehicles presenting adequate loading capacity, and the machines must be anchored to the established points.
- During handling and if required by the conditions, have one or more people assist in order to ensure adequate warnings.
- If the machine has to be moved with vehicles, ensure that they are suitable for the purpose, and perform loading and unloading without risks for the operator and for people directly involved in the process.
- Before transferring the equipment onto the vehicle, ensure that both the quasi-machine and its components are adequately secured, and that their profile does not exceed the maximum bulk allowed. Place the necessary warning signs, if necessary.
- Unload the axes in the immediate vicinity of the area of installation, and store them in an environment protected against weather.
- Failure to comply with the information provided might entail risks for the safety and health of people, and can cause economic loss.
- The Installation Manager must have the project to organize and monitor all operative phases.
- The installation site must have adequate environmental conditions (lighting, ventilation, etc.).
- The installation site temperature must be within the maximum and minimum range allowed.
- Ensure that the installation site is protected against weather, does not contain corrosive substances, and is free of the risk of explosion and/or fire.
- Installation in environments presenting a risk of explosion and/or of fire must ONLY be done if the machine has been DECLARED COMPLIANT for such use.

### > Packaging

- Packaging is done keeping in mind the bulk reduction.
- Transport can be facilitated by shipping certain components dismantled and appropriately protected and packaged.
- All necessary information for loading and unloading is written on the packaging.
- Every shipment is accompanied by a document ("Packing list") with the list and description of the axes.
- Packaging for maritime/air transport is the "barrier bag" type to guarantee preservation of the packaged elements.
- Bulk components are appropriately placed along with the axes (with or without packaging) to avoid sudden and unexpected movements.
- The packaging material must be appropriately disposed of in compliance with the legislation in force.

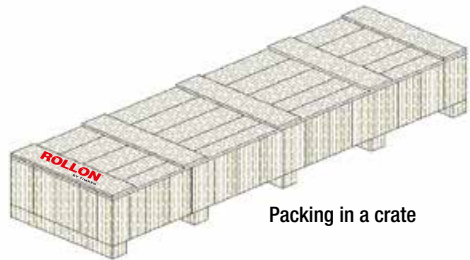

Packing in a crate

### > Transport

- Transport, also based on the final destination, can be done with different vehicles.
- Perform transport with suitable devices that have adequate loading capacity.
- Ensure that the quasi-machine and its components are adequately anchored to the vehicle.
- Mobile parts of the system are blocked before handling and transport.



## > Handling and lifting

Correctly connect the lifting devices to the established points on the boxes and/or on the packages.



Symbol indicating the center of mass of the package to handle



Symbol indicating the pick up points to use to lift the package

These symbols can be found on the Partly Completed Machinery or on the crate.

- Before handling, read the instructions, especially safety instructions, provided in the installation manual, on the packages and/or on the dismantled parts.
- DO NOT attempt, in any way, to bypass handling methods and the established lifting, moving and handling points of each package and/or dismantled part.
- Slowly lift the package to the minimum necessary height and move it with the utmost caution to avoid dangerous oscillations.
- Make sure you can see properly. DO NOT move the machine with an inadequate visual field and when there are obstacles along the route to the final location.
- DO NOT allow people to either transit or linger within the range of action when lifting and handling loads.
- Do not stack packages to avoid damaging them, and reduce the risk of sudden and dangerous movements.
- In case of prolonged storage, regularly ensure that there are no variations in the storage conditions of the packages.

## > Check axis integrity after shipment

Every shipment is accompanied by a document ("Packing list") with the list and description of the axes.

- When a shipment is received, check to make sure that the materials received correspond to specifications in the delivery document.
- Check that packaging is perfectly intact and, check that each axis is intact.
- In case of damage or missing parts, contact the manufacturer to define the relevant procedures.

## > Installation

- Fitting out the established location in advance makes it possible to avoid wasting the time of installation technicians.
- Evaluate in advance whether the machine must interact with other production units, and that integration can be implemented correctly, in compliance with standards and without risks.
- The manager shall assign installation and assembly interventions ONLY to authorized technicians with acknowledged know-how.
- State-of-the-art connections to power sources (electric, pneumatic, etc.) must be ensured, in compliance with relevant regulatory and legislative requirements.
- State-of-the-art connections, alignment and leveling are essential to avoid additional interventions and to ensure correct machine function.
- Upon completion of the connections, run a general check to ascertain that all work has been correctly carried out and to ensure compliance with requirements.
- Failure to comply with the information provided might entail risks for the safety and health of people, and can cause economic loss.

# CTU - basic components

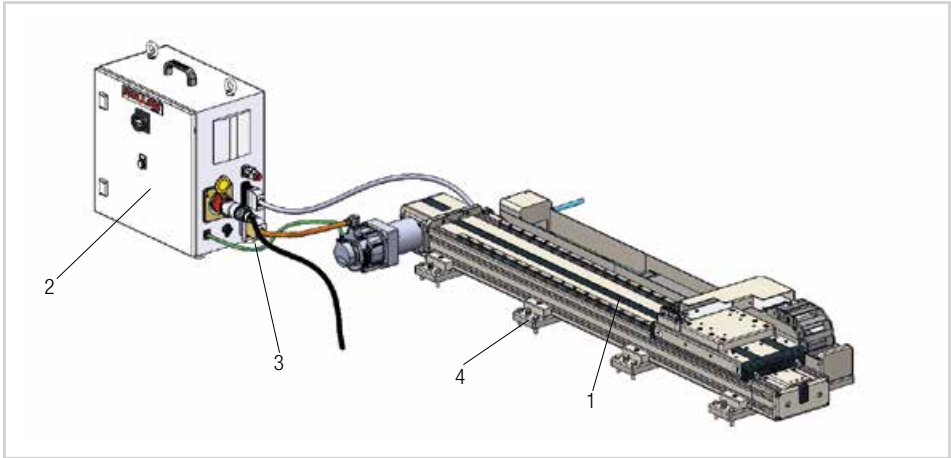

Fig. 1

## > What's included

CTU system is made up of:

- Rollon axis [1]
- Rollon electrical cabinet [2]
- Connection cables [3]
- Fixing and leveling screws [4]
- High-flex robot power and signal cable

(The components must be assembled)

## > Robot compatibility

CTU is available in different sizes:

Axis type	Robot type
CTU130-1I	UR3e
CTU160-1I	UR5e
CTU 220-1I	UR10e - UR10CB - UR16e

Tab. 2

### System requirements:

- Power supply: 380-480 V (power cable supplied with plug IEC 60309 4 pins 3P + E) 3A.
- UR model: CB series robot 3.1 onwards e-Series robot with Base Flange Connector. This is found on new e-Series systems, with part numbers 1103xx (eg. 110305 for UR5e w. Base Flange Connector).
- Polyscope 3.6 or higher.

# Specific system references

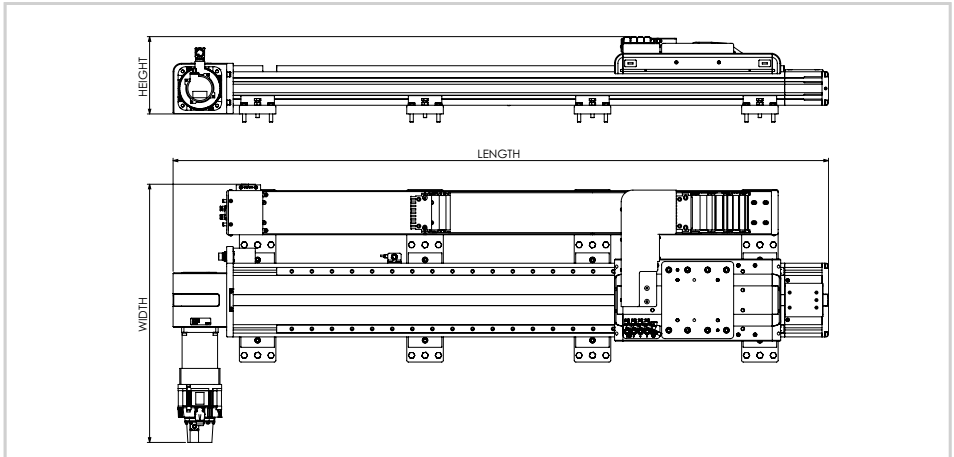

Fig. 2

	CTU130-11				CTU160-11				CTU220-11			
Stroke [mm]	Weight* [kg]	Length [mm]	Width [mm]	Height [mm]	Weight* [kg]	Length [mm]	Width [mm]	Height [mm]	Weight* [kg]	Length [mm]	Width [mm]	Height [mm]
500	46	1344	608 (662**)	211	73	1429	691 (727**)	239	99	1458	736 (788**)	231
1000	55	1844			88	1929			114	1958		
1500	64	2344			103	2429			133	2458		
2000	73	2844			117	2929			150	2958		
2500	81	3344			130	3429			167	3458		
3000	90	3844			145	3929			185	3958		
3500	99	4344			159	4429			202	4458		
4000	108	4844			174	4929			219	4958		
4500	116	5344			188	5429			236	5458		
5000	125	5844			202	5929			254	5958		
5500	134	6344	216	6429	271	6458						

\*Electrical cabinet weight 29 Kg not included.

\*\* Width for vertical configuration.

Tab. 3

## Maximum dynamic performance

V max [m/s]	a max [m/s <sup>2</sup> ]
1.5	3.0

Tab. 4

Main parts

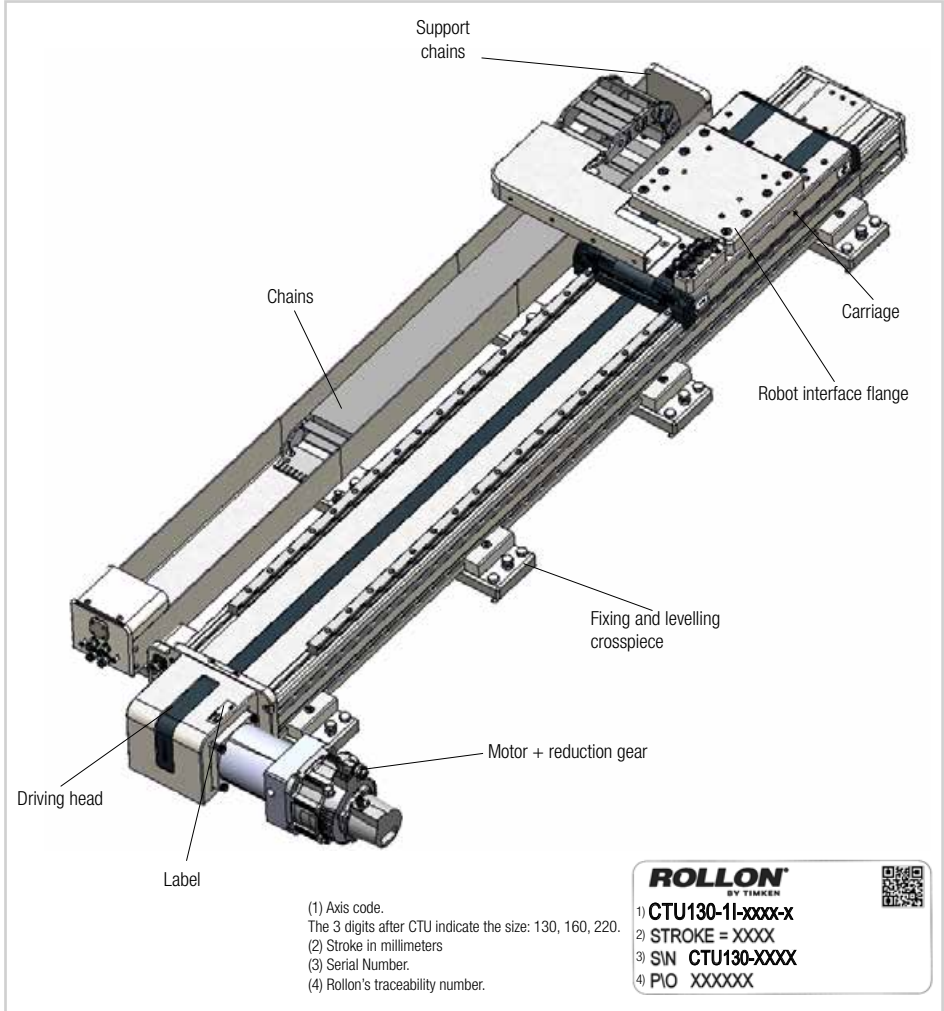

Fig. 3

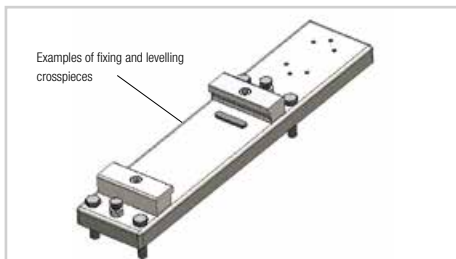

Fig. 4

All CTU systems have crosspieces that allow them to support the load-bearing profile and simultaneously fasten the entire structure together. The fixing crosspieces can also be used to level the entire system.

# Installation instructions



## > Handling CTU

Lift the system, making sure to set the lift truck forks under the beam that make up the system. Make sure that the lift truck forks are in points equidistant from the fixing crosspieces that support the load-bearing beam. Place the carriage in a central position on the axis to keep the weight balanced. Always monitor the load during handling to make sure that it does not tip over suddenly.

The images below will give you an idea for positioning the lifting points. Please consider them as indications only. They are to help explain what is written above.



### IMPORTANT!

If the mass of the individual pieces totals over 20 kg, to avoid damage or accidents to the operator(s), it is recommended to use lifting machines suited to the specific use and maneuvered by qualified technicians.

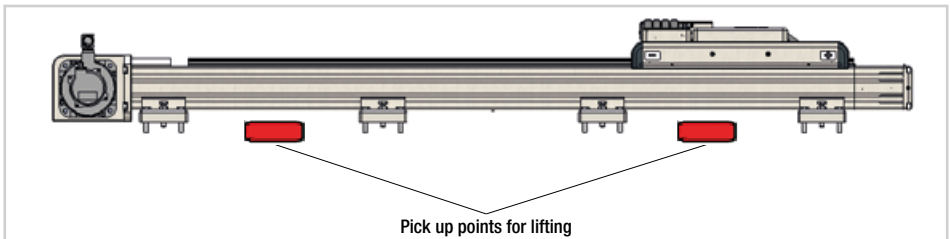

Fig. 5

## > Sensors

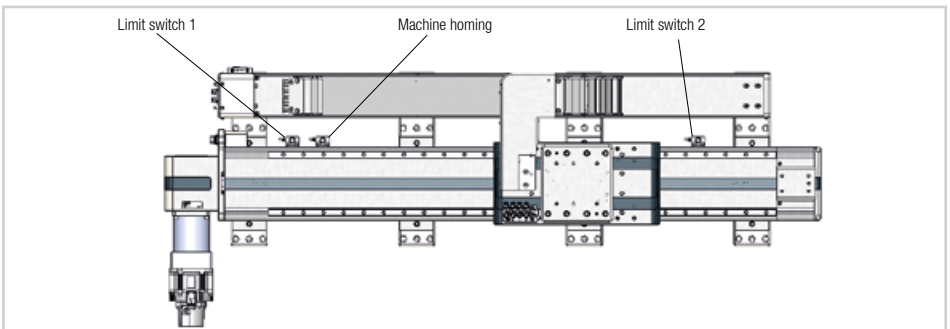

Fig. 6

The direction of the carriage  $-/+$  for programming is shown on the carriage sides. The direction “-” is towards the motor driving head, the direction “+” is towards the idle head.

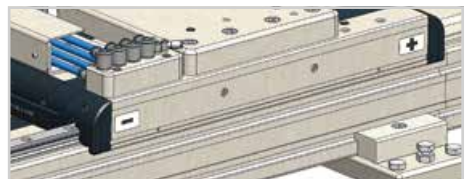

Fig. 7  
UM-11

## > Anchoring the CTU



Power down the system while any operation of assembly/disassembly is performed.

After placing the axis in its work position, turn the leveling screws to align it as desired and to compensate for possible misalignments due to irregular mounting surfaces. After levelling, tighten the two fixing screws with the torque indicated in the table.

Installation:

1. Position the axis with all leveling screws in full raised position;
2. Adjust the screws to achieve the desired alignment;
3. Fasten the fixing screws alternately and progressively. Do not fix a screw completely while having the other completely unfastened. Both should be tightened progressively and alternately until the specified torque is reached.

If the bolt provided is not of a suitable length, it can be replaced with one of a different length but of the same type and property class.

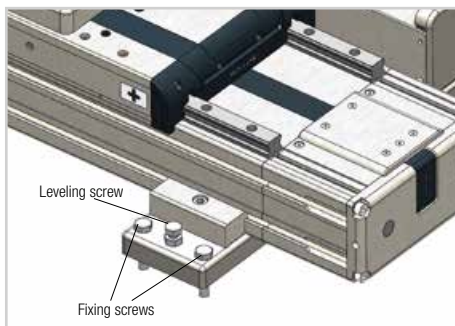

Fig. 8

**Fasten both fixing screws**



Fig. 9

	Hexagon head bolt with shank UNI 5737	Friction coefficient	Tightening torque [Nm]
			Property class 10.9
CTU130-11	M8x40	0.15	34
CTU160-11	M10x50		67
CTU220-11	M10x50		67

Tab. 5

### IMPORTANT!

All screws used for installing Rollon modules have “self-locking” washers or semi-permanent “threadlock” fluid (blue, such as Loctite 243). We recommend that the user also employ these devices, both while setting up the partially assembled machine described in this manual, and during the assembly or maintenance phases: if this is not done, the manufacturer of the partially assembled machine declines all responsibility for any accidents, breakage, damage and the consequences of said events on people, animals and property, due to the failure of fixing elements.



## > Mounting the robot on CTU



Power down the system while any operation of assembly/disassembly is performed.

Proceed with the installation of the robot in working position. The axis carriage is supplied with an adaptation counter plate for fixing the robot. This flange is custom made to be compatible with the robot base, and it is in turn anchored to the axis carriage. To anchor the robot to the interface flange, follow the instructions shown in the robot manual.

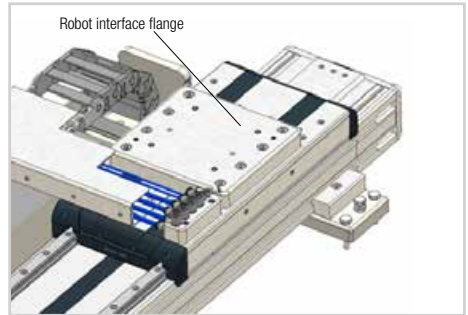

Fig. 10

### UR 10CB

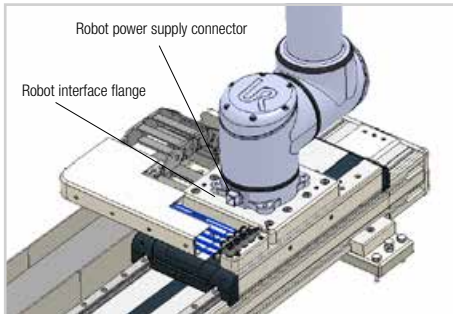

Fig. 11

### UR 10CB

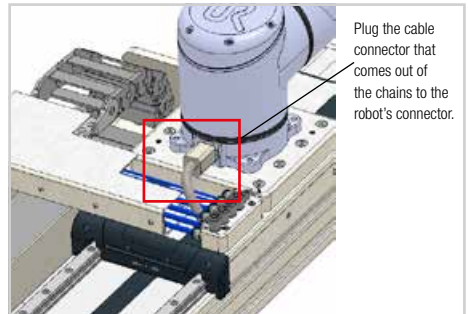

Fig. 12

### UR 3e, UR 5e, UR10e

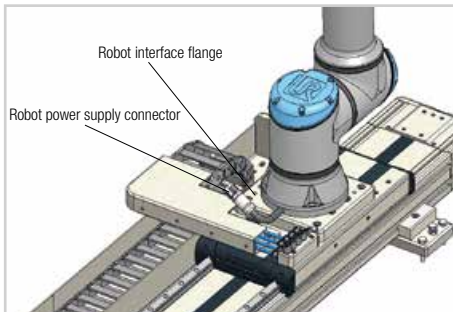

Fig. 13

### UR 3e, UR 5e, UR10e

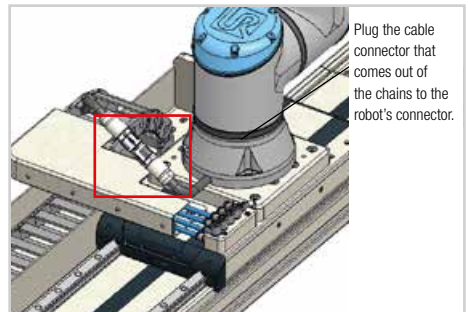

Fig. 14

## ➤ Connecting the CTU

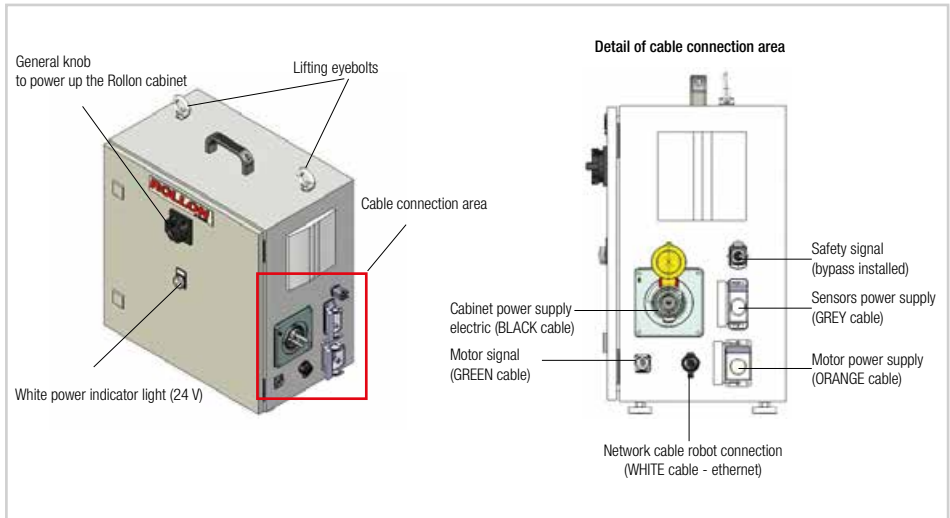

Fig. 15



The electrical cabinet is not supposed to be opened to use the system. All connectors are placed outside. In case of malfunctioning please contact Rollon.



Only use the original cables supplied with the CTU.



Power down the system while any operation of assembly/disassembly is performed.



The UR robot operates even if the CTU control cabinet is turned off.



It is mandatory to perform any operation of assembly/disassembly and cable connection/disconnection with the power down. Ensure the power is off and the white light is off.



**Procedure for connecting electrical cabinet cables:**

Cables coming out of the electrical cabinet;

- **ORANGE** cable - motor power,
- **GREEN** cable - motor signals,
- Power cable - electrical cabinet power supplied with plug IEC 60309 4 pins 3P + E (380-480V) 3A
- **GREY** cable - sensor power;
- **WHITE** cable - ethernet connection cable between the electrical cabinet of CTU and the robot.

Depending on the order the cables will be supplied in sections 3 or 5 meters in length.

\* On the cabinet a connector for safety signal is installed (e.g. laser scanner, safety mat, other safety devices, external safety door).

An external bypass is supplied.

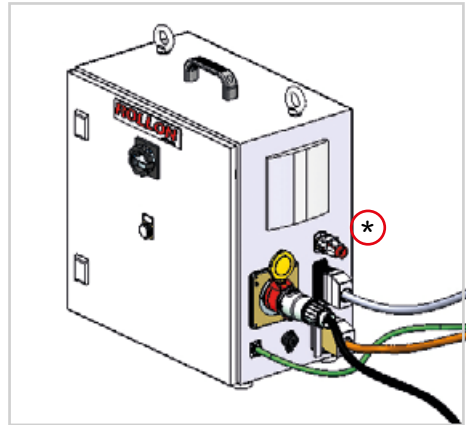

Fig. 16

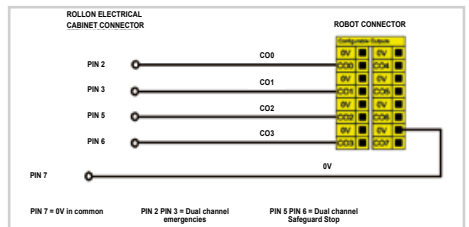

Fig. 17

The **GREY** cable must be plugged into the connector. This will activate the 3 positioning sensors.

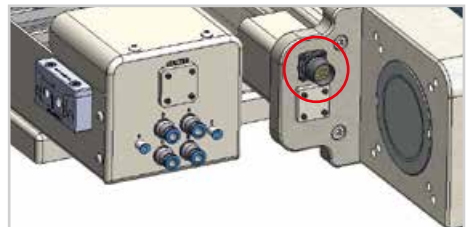

Fig. 18

Indications for connecting the **ORANGE** and **GREEN** cables to the motor

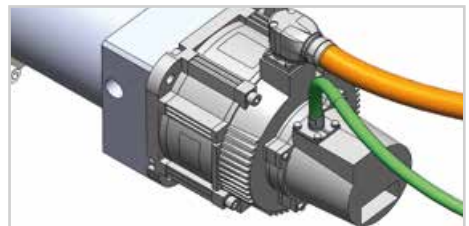

Fig. 19

**Procedure for turning on the electrical cabinet:**

1. Ensure that the machine is safe;
2. Turn the general knob to power up the electrical cabinet;
3. Make sure the white light (24 V) comes on;



To power up or power down the electrical cabinet turn the general knob.

## > Connecting the robot



Power down the system while any operation of assembly/disassembly is performed.



The UR robot operates even if the CTU control cabinet is turned off.

The electrical panel is supplied with the robot, not with the CTU. Make sure that all cables are connected;

- Small **BLACK** cable - electrical panel power (220 V),
- **BLUE** cable - High-Flex robot power and signal cable
- **WHITE** cable - Ethernet network connection cable between the electrical cabinets of CTU and the robot.



Pressing the emergency button of the robot stops the axis as well.



Fig. 20

Depending on the order the **WHITE** cable will be supplied in 3 or 5 meters length.



Fig. 21

The **BLUE** High-Flex robot power and signal cable is already inserted into the cable carrier in the axis chains. It is supplied 6m or 12m long based on CTU stroke (Page UM-13 for connecting the robot).

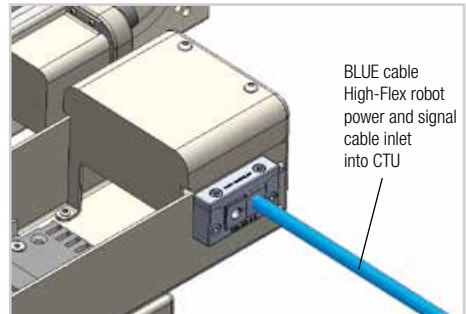

Fig. 22

## > Air connection

**(A-B-C-D)** Air inlets to power robot accessories (fig. 24 and 25). Corresponding air outlets are on the axis carriage (fig.23).

The cable carrier is supplied with 4 air cables.

**(E-F)** Air inlet for carriage clamping elements (fig. 25). Clamping elements optional if requested on order, see below chapter). Corresponding air outlets are on the axis carriage (fig. 23).

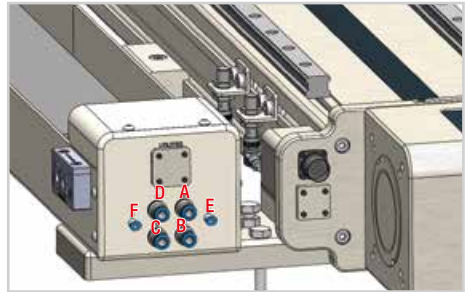

Fig. 24

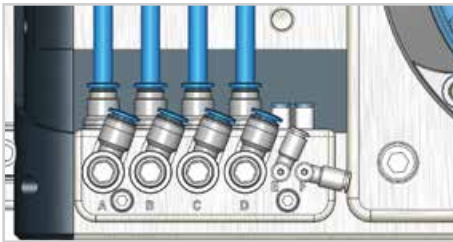

Fig. 23

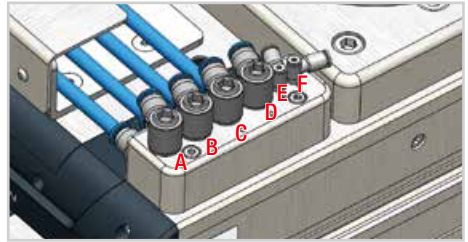

Fig. 25

## > Carriage clamping element (optional)

If requested during the order phase, the axis comes with clamping elements on the carriage that work on linear rails. With this option, the carriage presents open sides like the one shown in Fig.24. These are pneumatically activated elements. Pressurized air holds the clamping element open. The absence of pressurized air closes them and blocks the carriage. To unblock the carriage, it is necessary to restore pressure to the circuit. Working pressure: 5.5 bar.

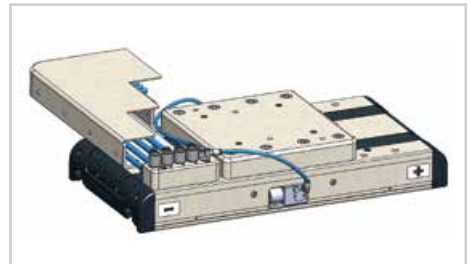

Fig. 26

Axis type	Clamping force [N]
CTU130-11	800
CTU160-11	1200
CTU220-11	1500

Tab. 6



Clamping force refers to both clamps actuated via E and F connections, do not activate only one connection.

## > Notes on lubrication

CTU features rails with self-lubricating recirculating ball bearings.

Carriages with recirculating ball bearings also have a retaining cage that eliminates the “steel on steel” contact between adjacent rolling bodies and prevents misalignments of these parts in the circuits.

Lubricant tanks are installed on the fronts of carriages with recirculating ball bearings. These small reservoirs release the right quantity of lubricant in the areas where the ball bearings support the applied loads.

This system guarantees long maintenance intervals: every 5000 km or once a year, whichever quantity is reached first.

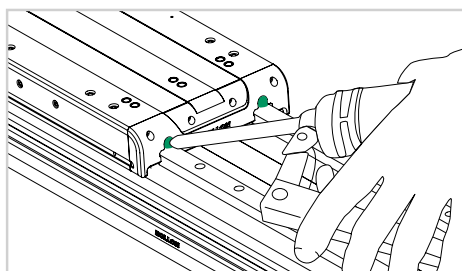

Fig. 27

- Insert the dispensing nozzle into the specific lubricator.
- Type of lubricant: class NLGI 2 lithium soap based grease.
- More frequent lubrication is necessary for heavy duty applications or difficult environmental conditions.

For more information, contact Rollon.

Quantity of grease necessary for re-lubricating each of the 4 blocks.

Type	Quantity [cm <sup>3</sup> ]
CTU130-11	0.7
CTU160-11	1.4
CTU220-11	2.4

Tab. 7

### Grease compatibility

	Lithium	Calcium	Lithium Calcium	Lithium Complex	Calcium Complex	Calcium Complex Sulfonate	Aluminum Complex	Polyurea	Bentone	Sodium
Lithium	+	+	+	+	-	+	×	×	×	×
Calcium	+	+	+	+	-	+	×	×	×	×
Lithium Calcium	+	+	+	+	-	+	×	×	×	×
Lithium Complex	+	+	+	+	+	+	×	-	×	×
Calcium Complex	-	-	-	+	+	-	×	+	×	×
Calcium Complex Sulfonate	+	+	+	+	-	+	×	-	×	×
Aluminum Complex	×	×	×	×	×	×	+	×	×	×
Polyurea	×	×	×	-	×	-	×	+	×	×
Bentone	×	×	×	×	×	×	×	×	+	×
Sodium	×	×	×	×	×	×	×	×	×	+

+ Compatible     
 - Compatible in certain Proportions     
 × Not compatible

## Rollon URCap manual (e-Series)



Before you start, download the last version of the program “Rollon URCap” on our website [www.rollon.com](http://www.rollon.com) and copy it to a USB key of your choosing. Updated firmware release is available for download as well.

### > Rollon URCap Installation

Turn on the robot following the instructions shown in the robot manual. To be programmed, the robot must be set in “Local” mode and not “Remote” (this option is not available for UR3).

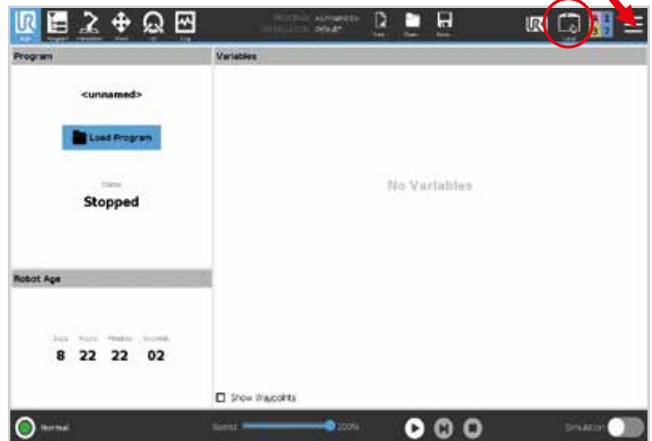

Fig. 28

Press “Settings”.

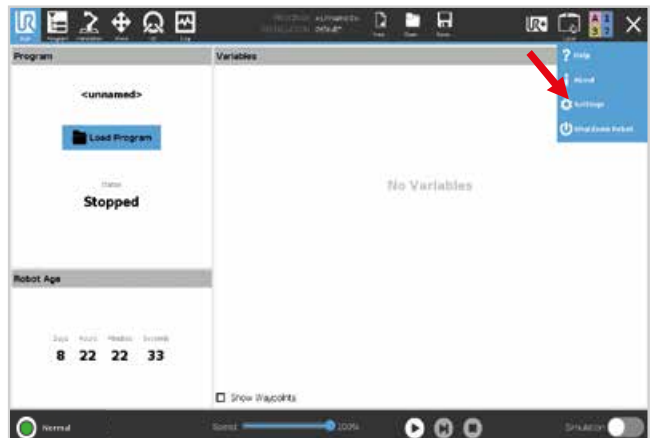

Fig. 29

Insert your USB key in the teach pendant. In the left menu select “System” then select “URCaps” and press “+” button.

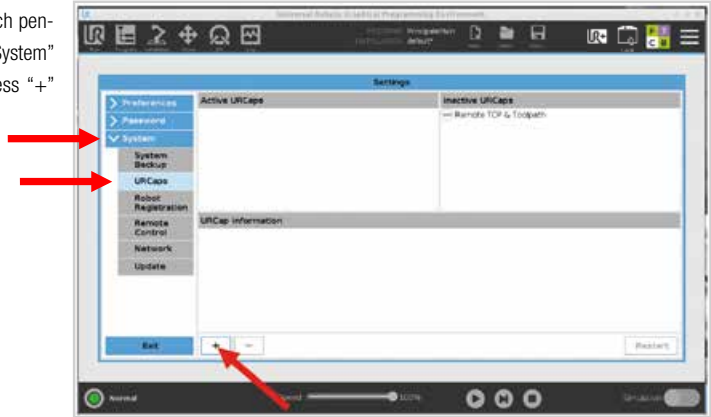

Fig. 30

Select “usbdisk”, locate the Rollon URCap program and press “Open”.

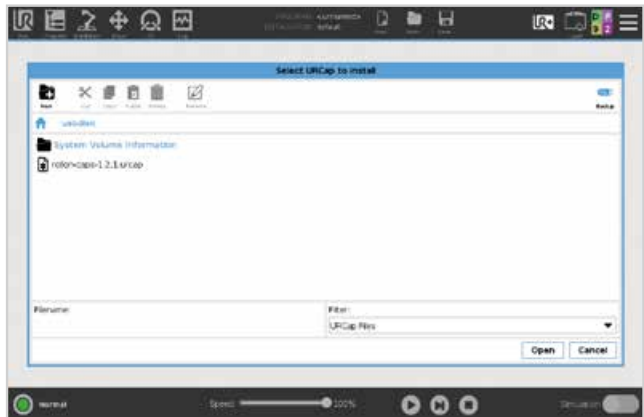

Fig. 31

Press “Restart” and wait for a few seconds.



Fig. 32

## ➤ Drive configuration

Turn on the robot following the instructions shown in the robot manual. In order to be programmed, the robot must be set in "Local" mode and not "Remote" (this option is not available for UR3).

Go to the "Installation" tab on the top menu, select "URCaps" and then select the correct axis size on the "Model" pop-up menu.

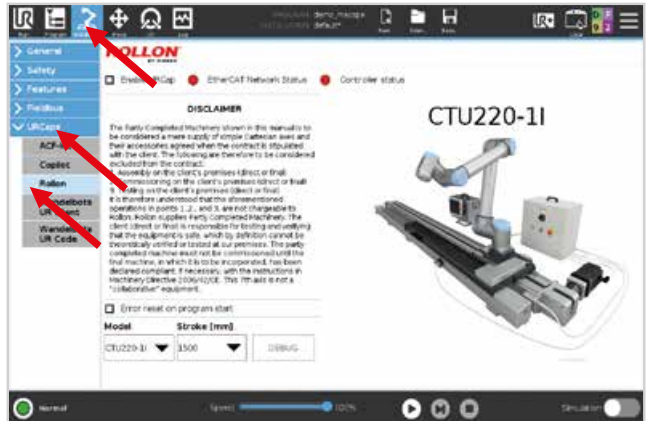

Fig. 33

If flagged, deactivate the "Enable UR-Cap" box to proceed with the axis selection.



Fig. 34

After selecting the size, select the correct "Stroke" from the popup menu. The stroke is visible on the axis' label.

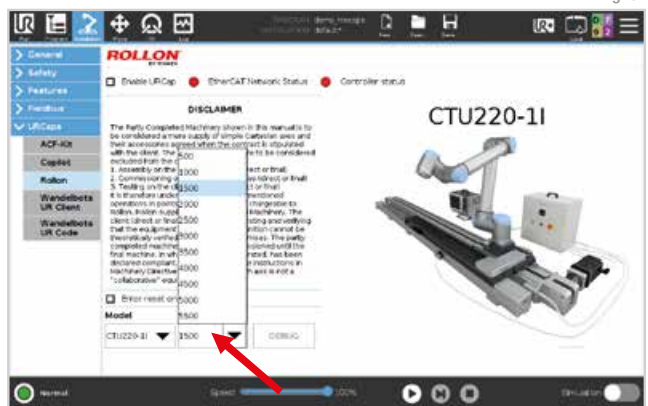

Fig. 35

Be sure to activate the flag “Enable URCap” before going on with the next steps.

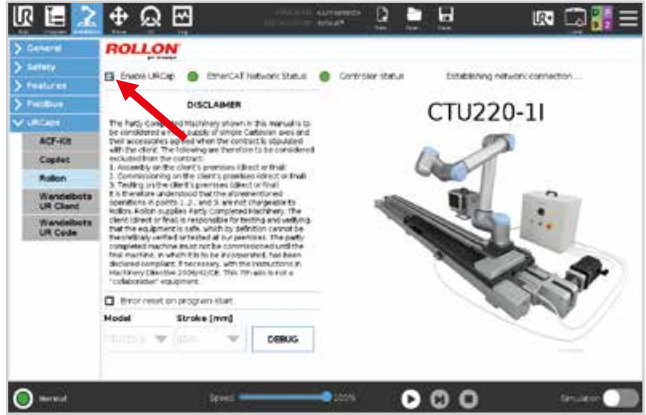

Fig. 36

## IP connection

If you only have one CTU in your net configuration, the IP configuration will be automatic. In case you have 2 cabinets, you'll need to set a separate IP address. In this case, go to the “Installation” tab of the menu, select “URCaps” and then “Rollon”, then click on the button “Debug”. Flag the “Custom” button, set the new IP address and press “Set IP Address”.

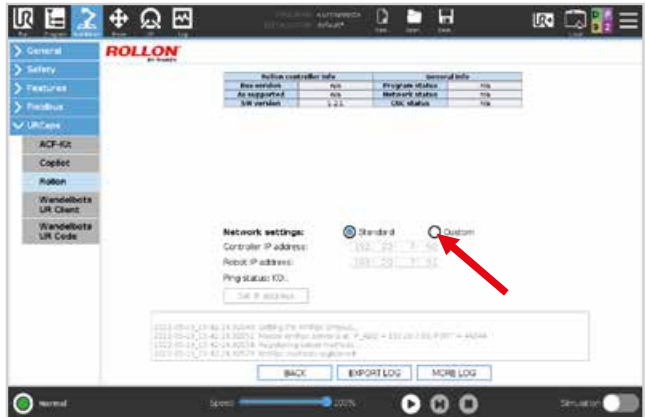

Fig. 37



## > Manual positioning of the axis

Pressing the “UR+” menu tab you can move the axis carriage in easy way and whenever you want. Press “Reset and Enable” if you see the red led “Safety On” to enable the manual movement. You can enable and disable the drive pressing “+” and “-” button. The axis will move in accordance with velocity and acceleration set. The “-” direction will move the carriage towards the motor. On the contrary, the “+” direction will move the carriage away from the motor.



Fig. 38

When programming, you can use the “Set Position” button of the “Move to target position” you can store the position reference reached manually. See pg. 25, fig. 46.

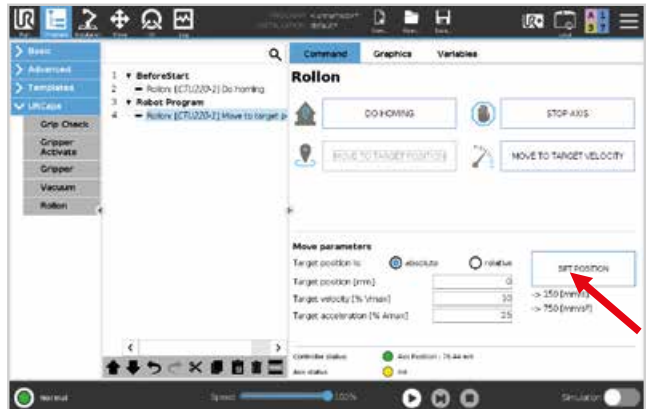

Fig. 39

In case you'll need to move the carriage by hand, you'll have to use the “Disable” command (this operation is strongly not suggested).



Fig. 40

## > Polyscope programming

Go to the “Program” tab in the top menu. In the left menu select “URCaps” and then “Rollon”.

In this window, you can set different instructions:

- Do homing
- Move to target position
- Move to target velocity
- Stop axis

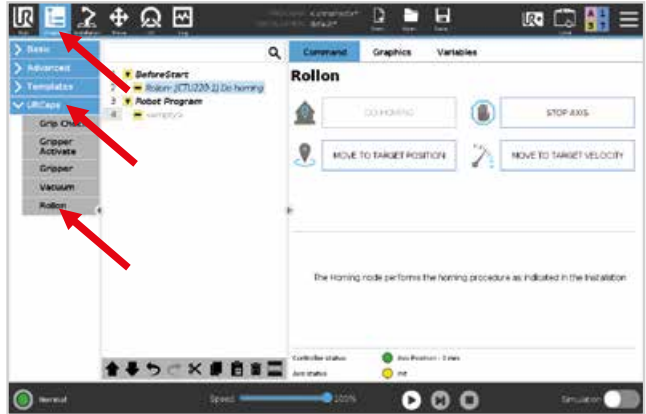

Fig. 41

After programming the cycle, click “Save” on the top menu to save the program.

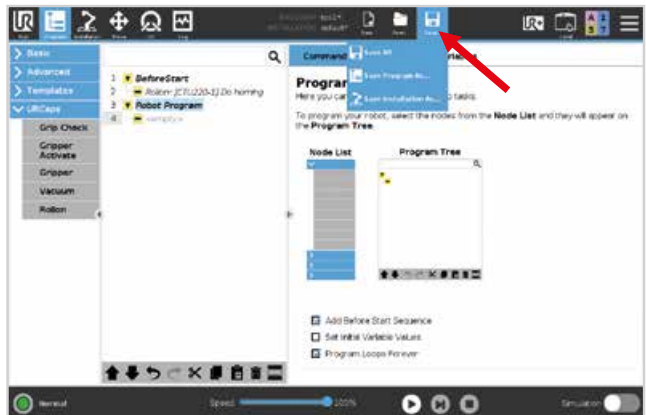

Fig. 42

If the URcap is not enabled, or the communication between YOUdrive and servo drive is not established, the program nodes will remain yellow. In this case, you need to unlock Safety pressing on the “UR+” tab and then on “Reset and Enable”.

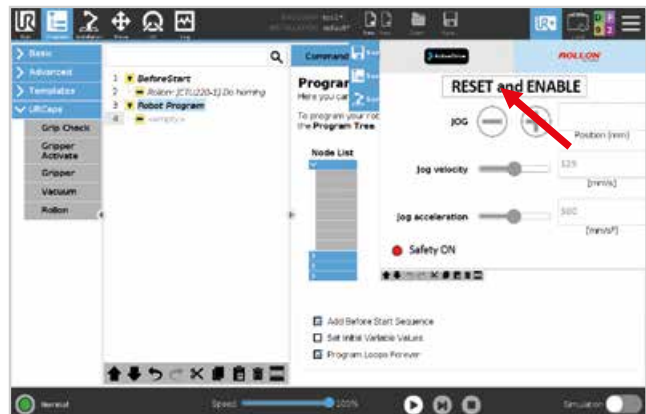

Fig. 43

## Do homing

The first instruction is “Do Homing”. This instruction does the homing, so the carriage will move to the side where the motor is installed.

It is necessary to “Do Homing” at least once when turning the system on, in order to reference the positioning of the motor. We suggest inserting this function in the “Before Start” method.

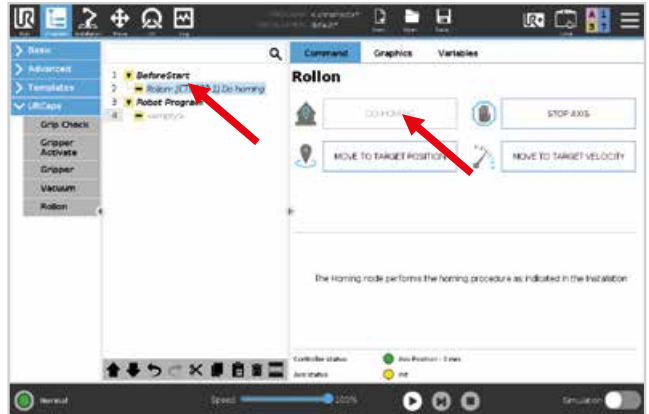

Fig. 44

## Move to target position

The second instruction is “Move to target position”. You can choose if the target position (configurable) is absolute, based on the homing, or relative. Also, velocity and acceleration are configurable values:

- Velocity is expressed in percentage of max allowable velocity (beside you can see the resulting velocity in mm/s).
- Acceleration is expressed in percentage of max allowable acceleration (beside you can see the resulting acceleration in mm/s<sup>2</sup>).

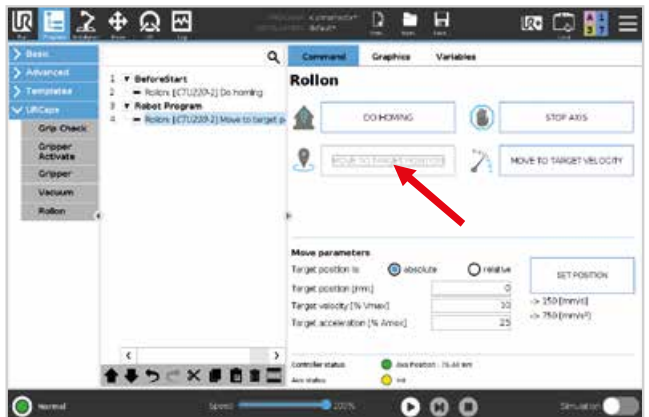

Fig. 45

The button “Set Position” sets the current position of the axis: you can manually move the axis in the desired position using the “UR+” menu tab, and then save it in the target position.

The two leds indicate YOUdrive status and Axis Status. “Axis position” indicates the current position of the axis.

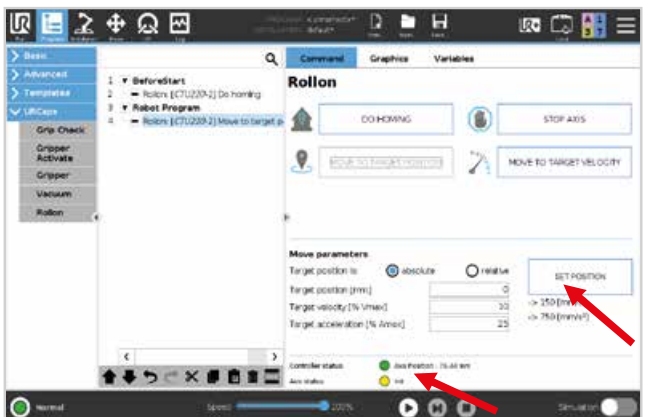



Fig. 46

### Move to target velocity

The third instruction is “Move to target velocity”. Please note that this is an endless movement command, so it is mandatory to enter a “Stop axis” command afterwards.

The velocity and acceleration are configurable values:

- Velocity is expressed in percentage of Max allowable velocity (beside you can see the resulting velocity in mm/s)
- Acceleration is expressed in percentage of Max allowable acceleration (beside you can see the resulting acceleration in mm/s<sup>2</sup>).

This symbol  indicates a movement in the negative direction (towards the motor), while  this a movement in the positive direction (away from the motor).

The two leds indicate YOUdrive status and Axis Status. “Axis position” indicates the current position of the axis.

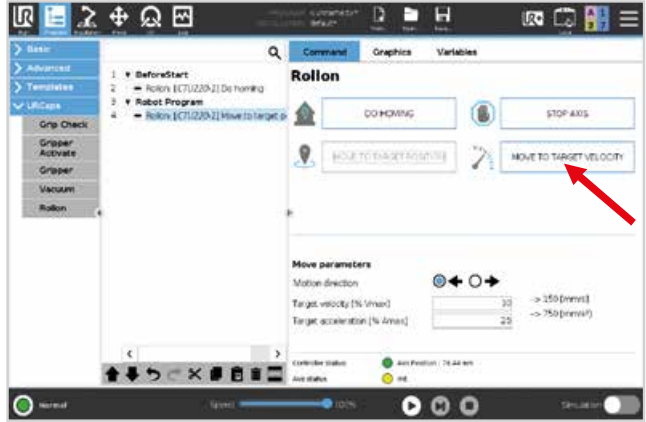

Fig. 47

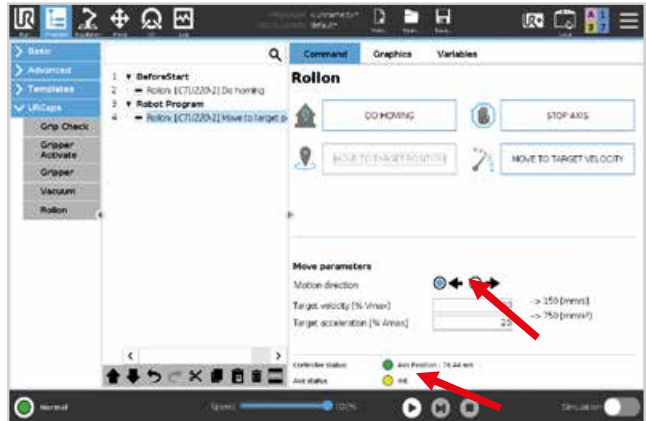

Fig. 48

### Stop Axis

After “Move to target velocity” command, you need to stop the axis before it touches the limit switch sensor. “Stop axis” does just that.

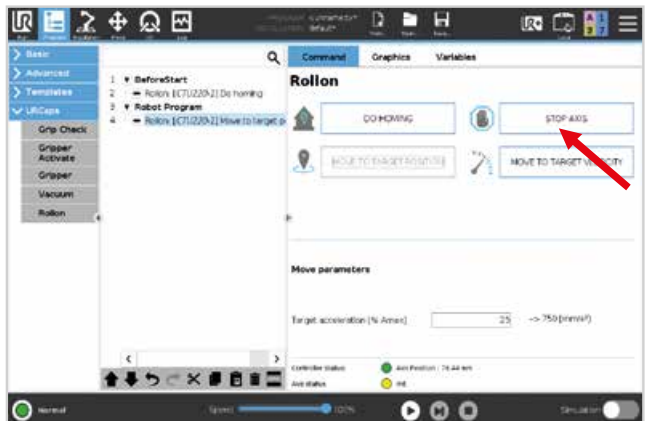

Fig. 49

## > Errors

As general indication, after fixing an error as explained in the following pages, you have to reset it using the “UR+” tab on the top menu, pressing the “Reset and Enable” button.



Fig. 50

Should you need further support, in order to speed up service we kindly invite you to send us a screenshot of the logs. You can get it by clicking on the “Installation” tab on the top menu, select “URCaps” and then “Rollon” in the left menu and finally clicking the button “Debug”. In the new window, select the “More Log” button to generate a detailed report that will be stored in the home robot directory.



Fig. 51

### Overtravel:

If something goes wrong, the carriage can go overtravel and reach the end stroke sensor. You will see this error. Press “Stop Program”.

To fix the overtravel error you have to manually move the carriage, as explained on pg. 23, in the opposite direction with respect to the error.



Fig. 52

### Lost communication with the control box:

If a connection problem occurs between the robot and the Rollon cabinet, you will see this error. In this case it is forbidden to restart the program. Press "Stop Program".

To fix this error, check that the white cable (ethernet) is correctly plugged in.



Fig. 53

### Safety ON:

In case you connect the safety signal (e.g. laser scanner, safety mat, other safety devices, external safety door) and you enable the safety function on Rollon cabinet connector, if the cable is unplugged you will see this error and the program will stop. Press "Stop Program".

To fix this error, check that the cable is correctly plugged in.



Fig. 54

### Encoder communication error:

If the encoder connection from the cabinet to the motor breaks down, or the cable is unplugged, you will see this error. Press "Stop Program" and switch off the Rollon cabinet (see pg. 15). This is the only case where you'll need to do so.

To fix this error, check that the green cable (encoder) is correctly plugged in.

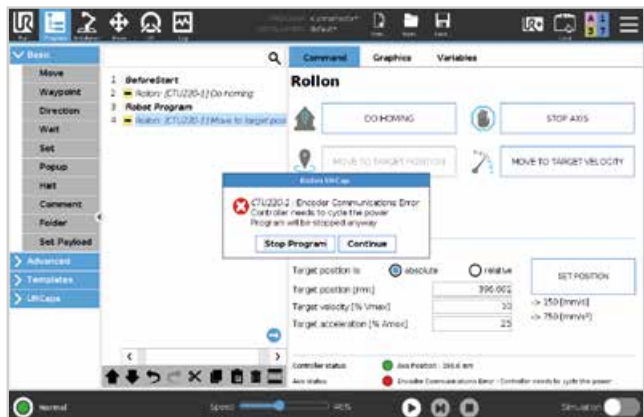

Fig. 55



**Overload:**

If the cabinet power is off, the power goes out, or the motor power cable is disconnected, you will see this error. This condition will also arise every time you switch on and off the cabinet.

The same error will also appear if the carriage movement is somehow prevented.

In any case, to fix this error press “Stop Program” check the power, the orange cable (motor power) or the carriage and then reset the error.



Fig. 56



When the robot stops due to an impact against an obstacle, the axis stops as well.



We remind that the CTU is not a collaborative equipment and there are no sensors on the axis carriage or at the base of the robot to detect impacts. Assessments for safety must be performed.

## > Support

For more information and support, visit our website or contact our technical department:

- **Email:** infotec@rollon.com
- **Telephone:** +39 039 62591

Should you need further support, in order to speed up service we kindly invite you to send us a screenshot of the logs. You can get it by clicking on the “Installation” tab on the top menu, select “URCaps” and then “Rollon” in the left menu and finally clicking the button “Debug”. In the new window, select the “More Log” button to generate a detailed report that will be stored in the home robot directory.



Fig. 57

## Rollon URCap manual (CB-Series)



Before you start, download the last version of the program "Rollon URCap" on our website [www.rollon.com](http://www.rollon.com) and copy it to a USB key of your choosing. Updated firmware release is available for download as well.

### > Rollon URCap installation

Turn on the robot following the instructions shown in the robot manual. When the robot is on, you'll see this screen. A popup might appear, select "Not now".

Press "Setup Robot".

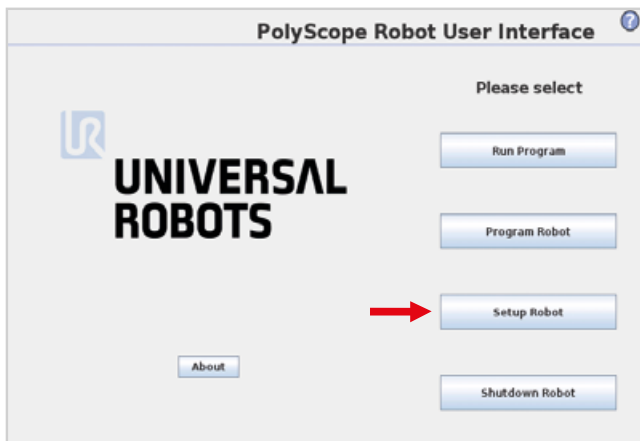

Fig. 58

Press "URCaps".



Fig. 59



Insert your USB key in the teach pendant and press “+” button.

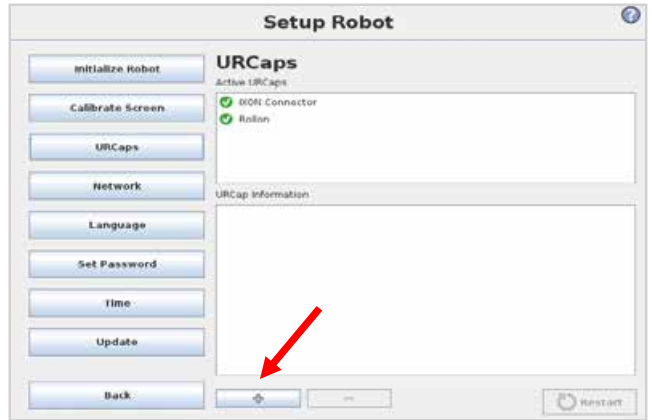

Fig. 60

Select “usbdisk”, locate the Rollon URCap program and press “Open”.



Fig. 61

Press “Restart” and wait for a few seconds.



Fig. 62

## ➤ Drive configuration

Turn on the robot following the instructions shown in the robot manual. When the robot is on, you'll see this screen. A popup might appear, select "Not now".

Select "Program robot".

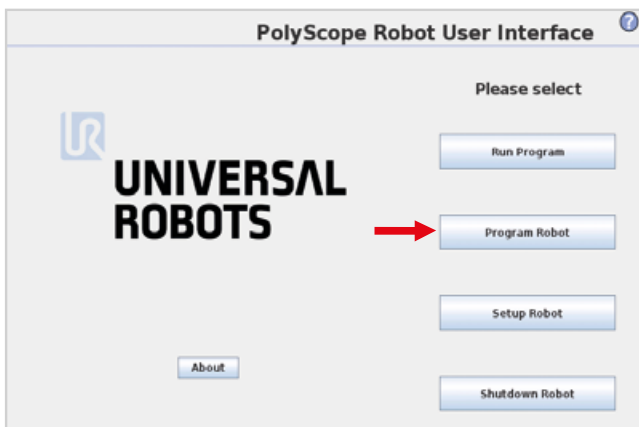

Fig. 63

Go to the "Installation" tab on the top menu and select "Rollon" on the left menu.

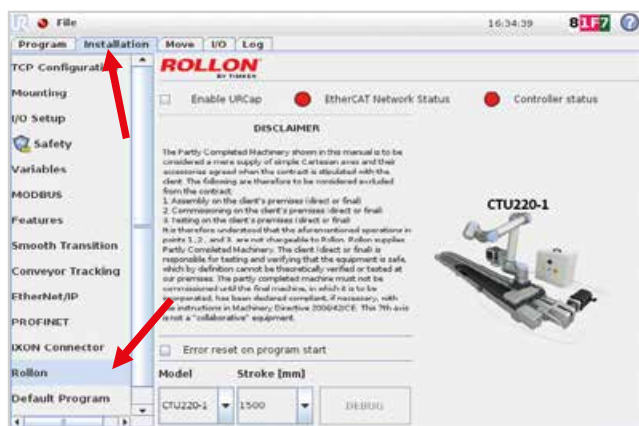

Fig. 64

If flagged, deactivate the "Enable UR-Cap" box in order to proceed with the axis selection, then select the correct axis size on the "Model" popup menu.

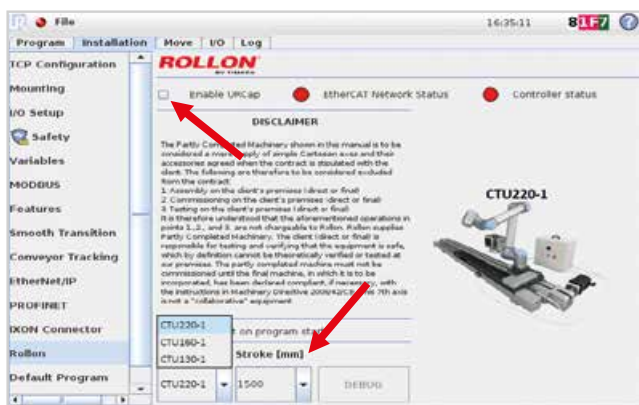

Fig. 65

After selecting the size, select the correct "Stroke" from the popup menu. The stroke is visible on the axis' label.

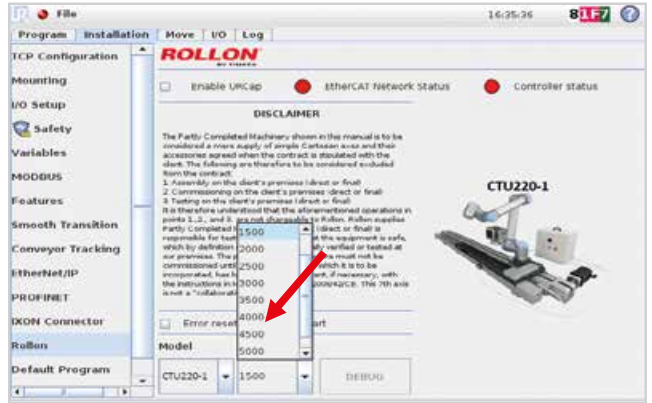

Fig. 66

Be sure to activate the flag "Enable URCap" before going on with the next steps.

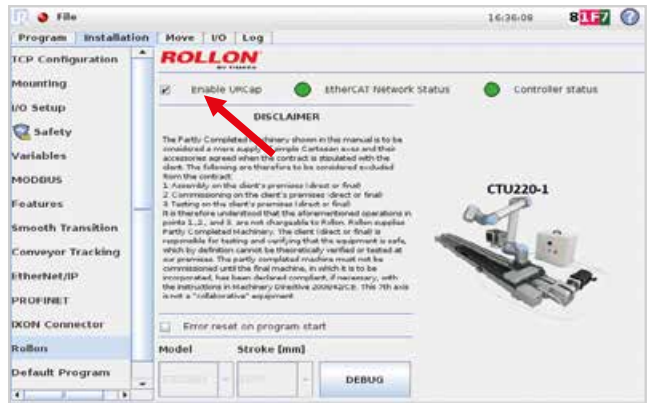

Fig. 67

## ➤ IP connection

If you only have one CTU in your net configuration, the IP configuration will be automatic. In case you have 2 cabinets, you'll need to set a separate IP address. In this case, go to the "Installation" tab of the menu, select "Rollon" and then click on the button "Debug". Flag the "Custom" button, set the new IP address and press "Set IP Address".

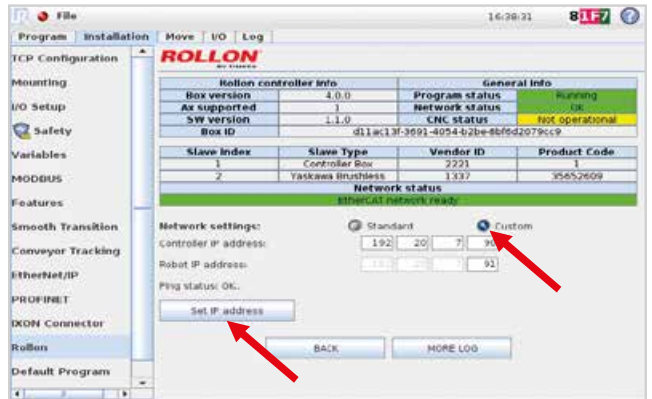

Fig. 68

## ➤ Manual positioning of the axis

From the “Program” tab, you can move the axis carriage in easy way and whenever you want using the “Jog” section, which is always visible under the 4 program instructions.

Press “Reset and Enable” if you see the red led “Safety On” to enable the manual movement.

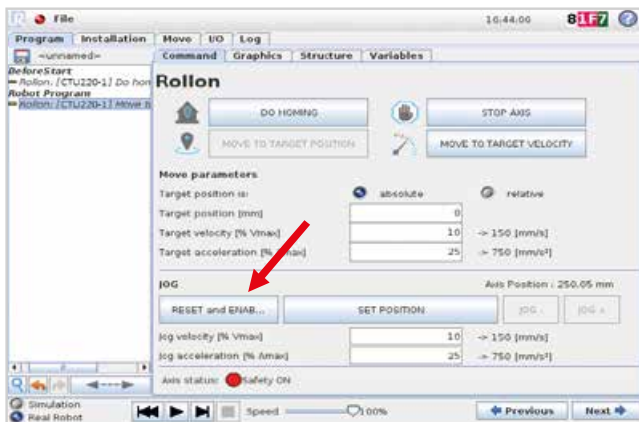

Fig. 69

Now you can enable and disable the drive pressing plus and minus button. The axis will move in accordance with velocity and acceleration set. The “-” direction will move the carriage towards the motor. On the contrary, the “+” direction will move the carriage away from the motor.

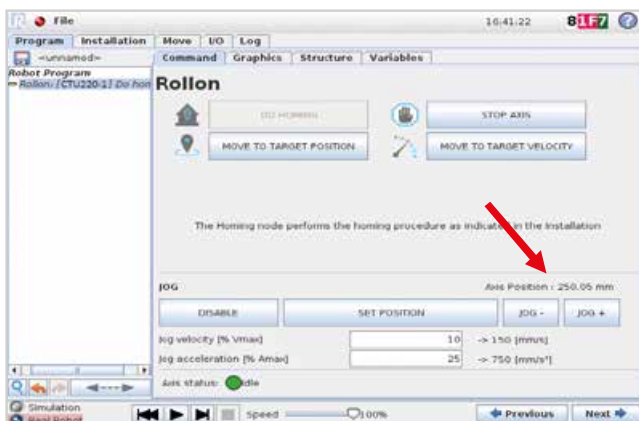

Fig. 70

When programming, you can use the “Set Position” button of the “Move to target position” to store the position reference reached manually. See pg. 37 fig. 78.



Fig. 71

In case you'll need to move the carriage by hand, you'll have to use the "Disable" command (this operation is strongly not suggested).



Fig. 72

## ➤ Polyscope programming

To start programming, select "Program robot" on the starting screen and then upload your program or create a new one clicking "Empty program".

From the top menu, select "Structure", then "URCaps", then "Rollon".

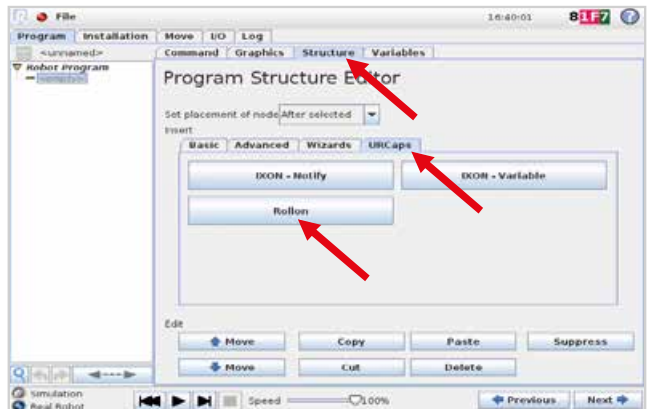

Fig. 73

Now move from "Structure" to "Command", in the same menu, to set the different instructions:

- Do homing
- Move to target position
- Move to target velocity
- Stop axis

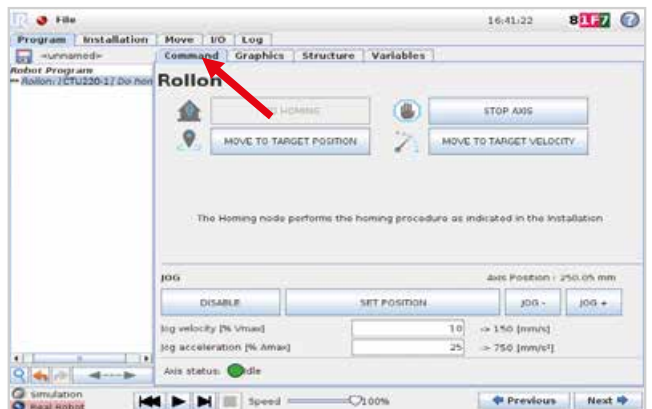

Fig. 74

If the URcap is not enabled, or the communication between YOUdrive and servo drive is not established, the program nodes will remain yellow. In this case, you need to unlock Safety pressing on the “UR+” tab and then on “Reset and Enable”.

## Do homing

The first instruction is “Do Homing”. This instruction does the homing, so the carriage will move to the side where the motor is installed.

It is necessary to “Do Homing” at least once when turning the system on, in order to reference the positioning of the motor. We suggest to insert this function in the “Before Start” method.

## Move to target position

The second instruction is “Move to target position”. You can choose if the target position (configurable) is absolute, based on the homing, or relative.

Also, velocity and acceleration are configurable values:

- Velocity is expressed in percentage of max allowable velocity (beside you can see the resulting velocity in mm/s).
- Acceleration is expressed in percentage of max allowable acceleration (beside you can see the resulting acceleration in mm/s<sup>2</sup>).

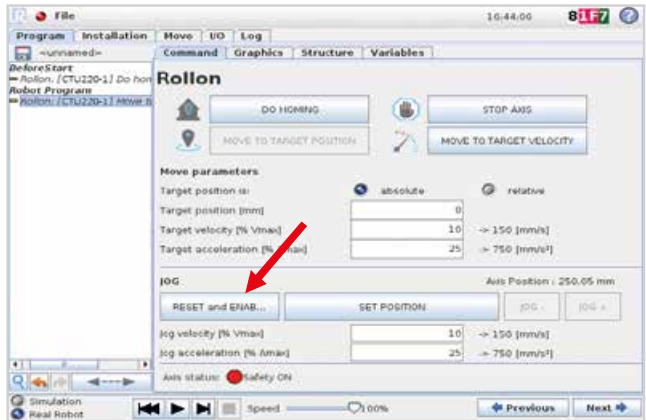

Fig. 75

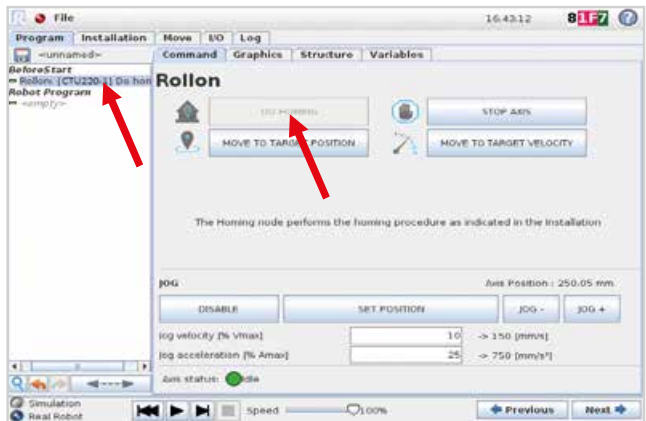

Fig. 76



Fig. 77



The button “Set Position” sets the current position of the axis: you can manually move the axis in the desired position using the “Jog” section, which is always visible under the 4 program instructions, and then save it in the target position.

The colorful led indicates the axis status.



Fig. 78

### Move to target velocity

The third instruction is “Move to target velocity”. Please note that this is an endless movement command, so it is mandatory to enter a “Stop axis” command afterwards.

The velocity and acceleration are configurable values:

- Velocity is expressed in percentage of Max allowable velocity (beside you can see the resulting velocity in mm/s)
- Acceleration is expressed in percentage of Max allowable acceleration (beside you can see the resulting acceleration in mm/s<sup>2</sup>).



Fig. 79

This symbol  $\ominus \leftarrow$  indicates a movement in the negative direction (towards the motor), while  $\ominus \rightarrow$  this a movement in the positive direction (away from the motor).

The colorful led indicates the axis status.



Fig. 80

## Stop Axis

After "Move to target velocity" command, you need to stop the axis before it touches the limit switch sensor. "Stop axis" does just that.

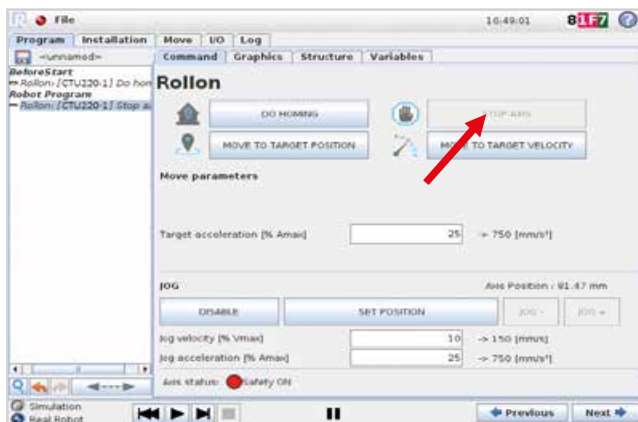

Fig. 81



## > Errors

As general indication, after fixing an error as explained in the following pages, you have to reset it using the “Jog” section, which is always visible under the 4 program instructions, pressing the “Reset and Enable” button.

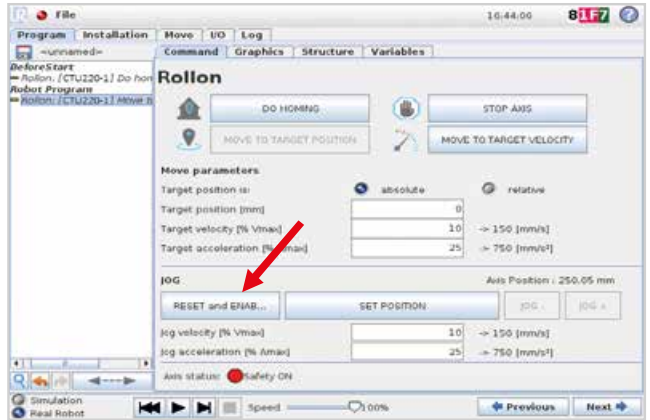

Fig. 82

Should you need further support, in order to speed up service we kindly invite you to send us a screenshot of the logs. You can get it by clicking on the “Installation” tab on the top menu, select “Rollon” in the left menu and click the button “Debug”. In the new window, select the “More Log” button to generate a detailed report that will be stored in the home robot directory.

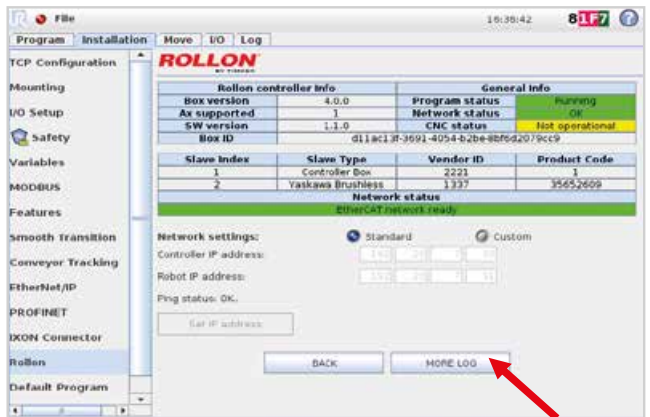

Fig. 83

### Overtravel:

If something goes wrong, the carriage can go overtravel and reach the end stroke sensor. You will see this error. Press “Stop Program”.

To fix the overtravel error you have to manually move the carriage, as explained on pg. 34, in the opposite direction with respect to the error.

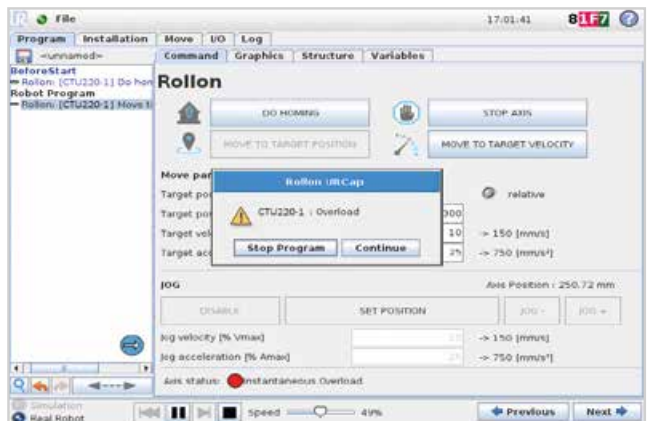

Fig. 84

### Lost communication with the control box:

If a connection problem occurs between the robot and the Rollon cabinet, you will see this error. In this case it is forbidden to restart the program. Press “Stop Program”.

To fix this error, check that the white cable (ethernet) is correctly plugged in.



Fig. 85

### Safety ON:

In case you connect the safety signal (e.g., laser scanner, safety mat, other safety devices, external safety door) and you enable the safety function on Rollon cabinet connector, if the cable is unplugged you will see this error and the program will stop. Press “Stop Program”.

To fix this error, check that the cable is correctly plugged in.



Fig. 86

### Encoder communication error:

If the encoder connection from the cabinet to the motor breaks down, or the cable is unplugged, you will see this error. Press “Stop Program” and switch off the Rollon cabinet (see pg. 15). This is the only case where you'll need to do so.

To fix this error, check that the green cable (encoder) is correctly plugged in.



Fig. 87

**Overload:**

If the cabinet power is off, the power goes out, or the motor power cable is disconnected, you will see this error. This condition will also arise every time you switch on and off the cabinet.

The same error will also appear if the carriage movement is somehow prevented.

In any case, to fix this error press “Stop Program” check the power, the orange cable (motor power) or the carriage and then reset the error.

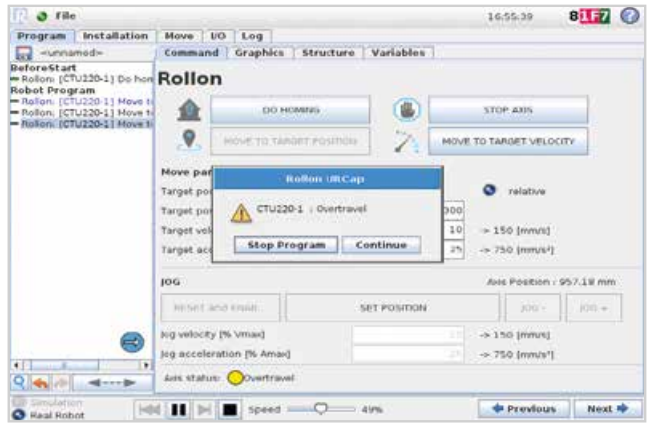

Fig. 88



When the robot stops due to an impact against an obstacle, the axis stops as well.



We remind that the CTU is not a collaborative equipment and there are no sensors on the axis carriage or at the base of the robot to detect impacts. Assessments for safety must be performed.

**> Support**

For more information and support, visit our website or contact our technical department:

- **Email:** infotec@rollon.com
- **Telephone:** +39 039 62591

Should you need further support, in order to speed up service we kindly invite you to send us a screenshot of the logs. You can get it by clicking on the “Installation” tab on the top menu, select “Rollon” in the left menu and click the button “Debug”. In the new window, select the “More Log” button to generate a detailed report that will be stored in the home robot directory.



Fig. 89

**Notes** 

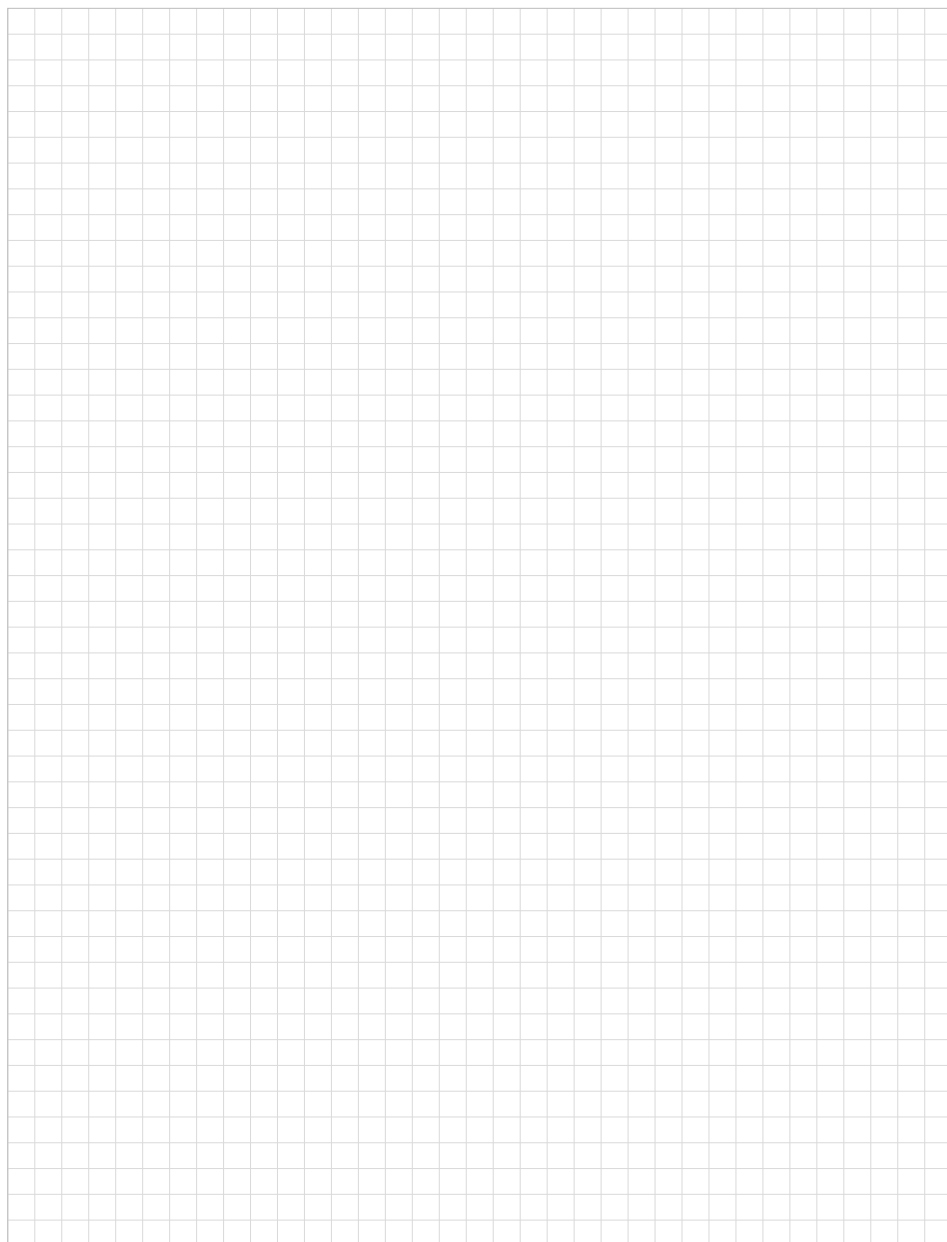



**Notes** 

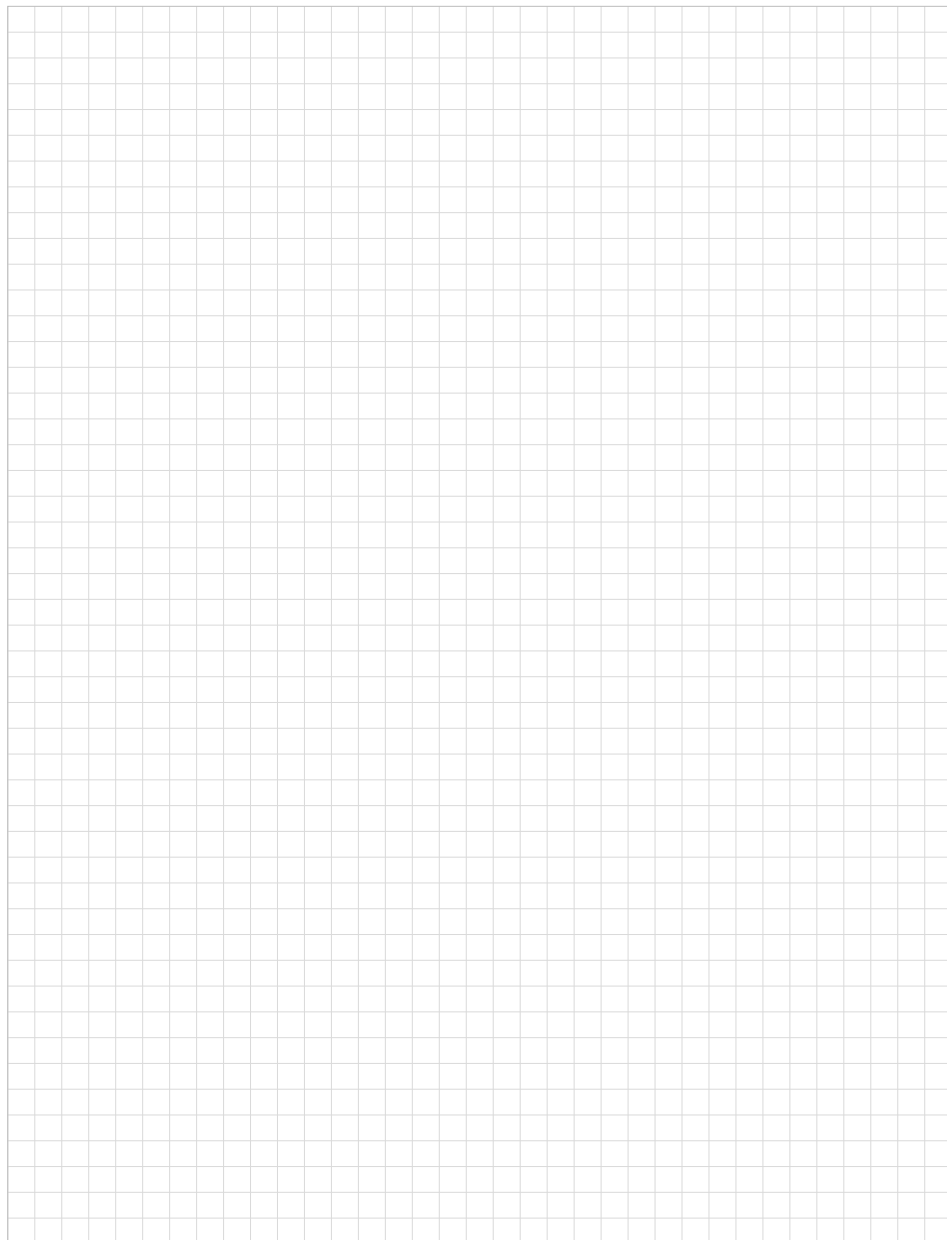



## EUROPE

### ROLLON S.p.A. - ITALY

Via Trieste 26  
20871 Vimercate (MB)  
Phone +39 039 62591  
infocom@rollon.com  
www.rollon.com

### ROLLON GMBH - GERMANY

Bonner Straße 317-319  
40589 Düsseldorf  
Phone +49 (0)211957470  
info@rollon.de  
www.rollon.de

### ROLLON S.A.R.L. - FRANCE

Les Jardins d'Eole 2 allée des Séquoias  
69760 Limonest  
Phone +33 (0)474719330  
infocom@rollon.fr  
www.rollon.fr

### ROLLON LTD. - UK (Rep. Office)

The Works 6 West Street  
Olney, Buckinghamshire  
United Kingdom, MK46 5 HR  
Phone +44 (0) 1234964024  
ukandireland@rollon.com  
www.rollon.uk.com

## AMERICA

### ROLLON CORP. - USA

101 Bilby Road, Suite B  
Hackettstown, NJ 07840  
Phone +1 973 300 5492  
info@rollon.com  
www.rollon.com

### ROLLON - SOUTH AMERICA

101 Bilby Road, Suite B  
Hackettstown, NJ 07840  
Phone +1 973 300 5492  
info@rollon.com  
www.rollon.com

## ASIA

### ROLLON LTD. - CHINA

No. 1155 Pang Jin Road,  
China, Suzhou, 215200  
Phone +86 0512 6392 1625  
info@rollon.cn  
www.rollon.cn.com

### ROLLON INDIA PVT. LTD. / INDIA

39-42, Electronic City, Phase-I,  
Hosur Road, Bangalore-560100  
www.rollonindia.in - info@rollonindia.in

### ROLLON S.P.A. - JAPAN

〒252-0131  
神奈川県相模原市緑区西橋本1-21-4  
橋本屋ビル  
電話番号: 042-703-4101  
www.rollon.jp - info@rollon.jp

**ROLLON**<sup>®</sup>  
BY TIMKEN