

# ROLLON®

BY TIMKEN

Linear Line

Telescopic Line

Actuator Line

Actuator System Line

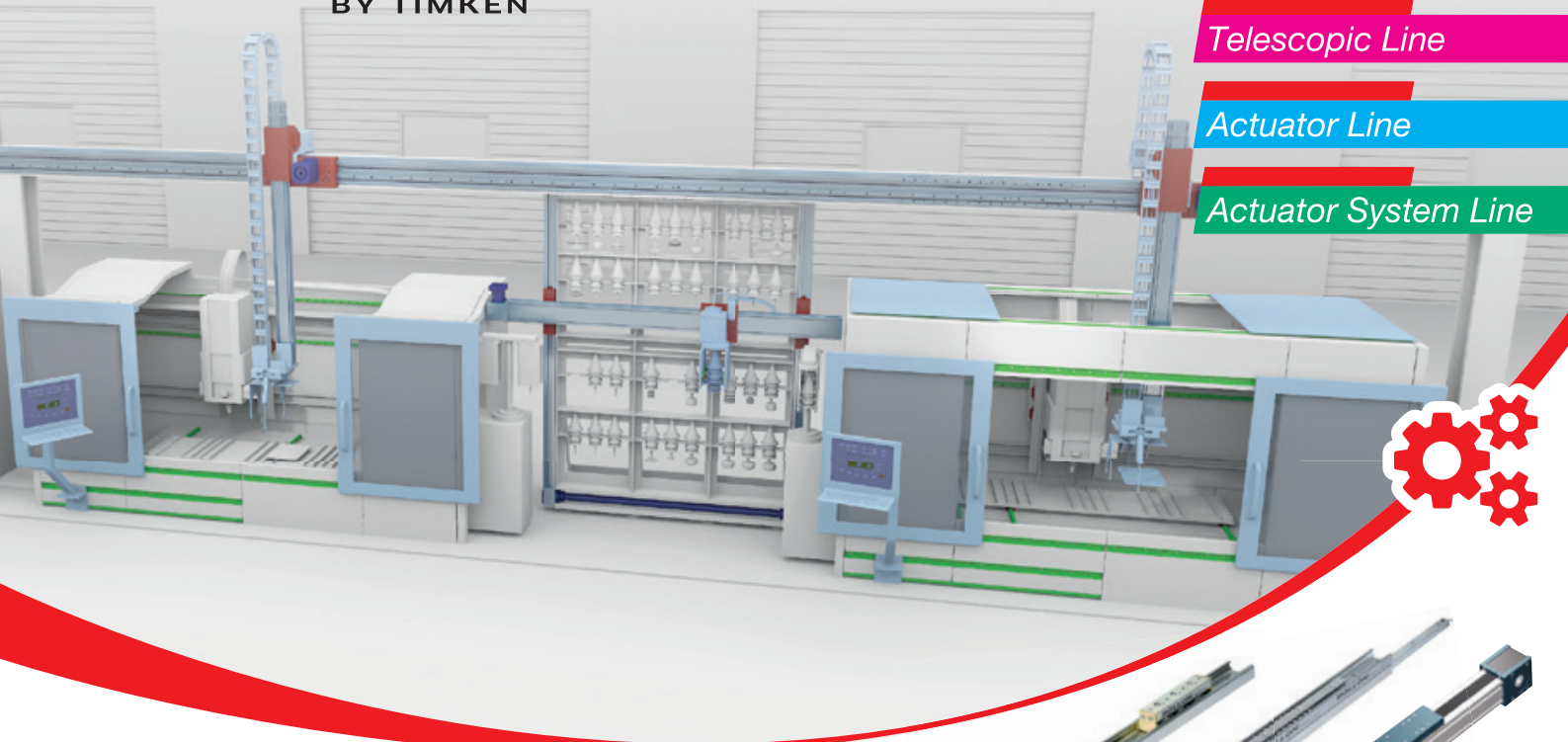

**Lineare Lösungen für den Maschinenbau**  
**Linear solutions for industrial machines**

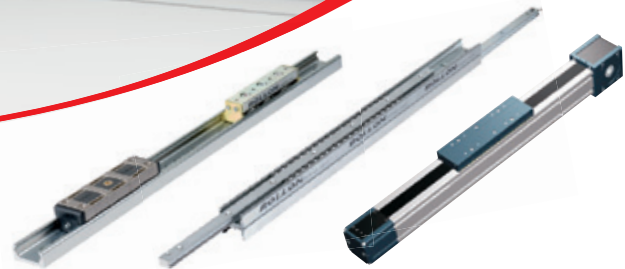

**Immer für Sie in Bewegung  
When you move, we move**

Seit 1975 ist Rollon ein international führender Hersteller von Linearlagern, Antrieben und Lineartechnik Produkten, die den Ansprüchen seiner industriellen Stammkunden übertreffen. Die Produktfamilien von Rollon bieten höchste Qualität und wirtschaftliche Antworten auf die Anforderungen der Industrie. Der größte zusätzliche Nutzen besteht in der Leistungsfähigkeit das Produkt entsprechend der Anwendung anzupassen, so dass, falls benötigt, das Produkt individuell auf jeden Kunden zugeschnitten werden kann.

*ROLLON has been a leading international linear motion manufacturer since 1975 providing linear bearings, actuators and linear motion products that surpass the needs of its industrial customer base. ROLLON's family of products provides high quality, cost-effective answers to standardized industry requirements. The biggest added value is given by the ability to personalize the product according to the application so that if needed, the product becomes "unique for each customer".*

**ROLLON<sup>®</sup>**  
BY TIMKEN

> Automatische Werkzeugmaschinen Türen  
Automated Machine Tool Doors

> Be- und Entladesystem von Werkstücken  
Loading & unloading of the machined piece

> Schubladenauszug  
Drawer extraction

> Werkzeugmaschinen Türöffnung  
Machine tool opening door

> Automatischer Werkzeugwechsler  
Tool changer robot

> Bedienungspult Verschiebung  
Screen sliding

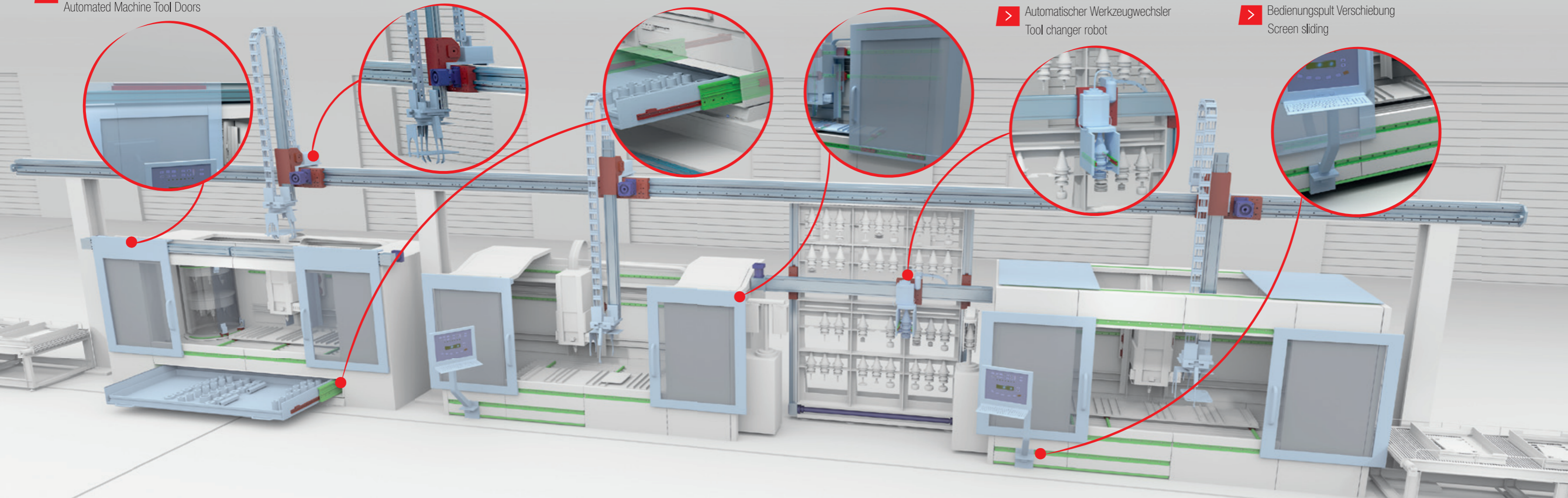



> Y-Z Achse von Wasserstrahlschneidanlagen  
Y-Z axes of water-jet cutting machine

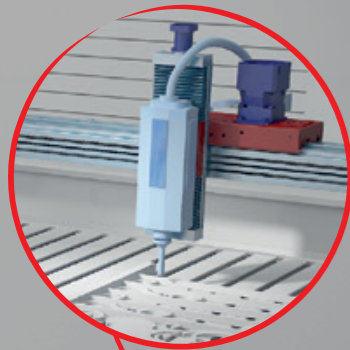

> X-Achse von Wasserstrahlschneidanlagen  
X axis of water-jet cutting machine

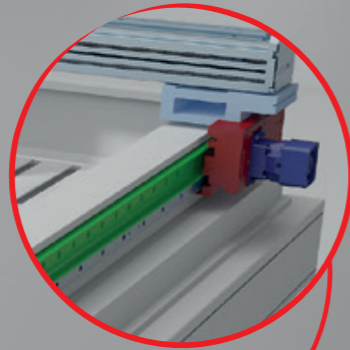

> Hinteranschlag  
Back gauge

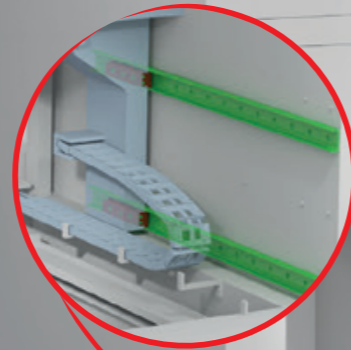

> Hinteranschlag  
Back gauge

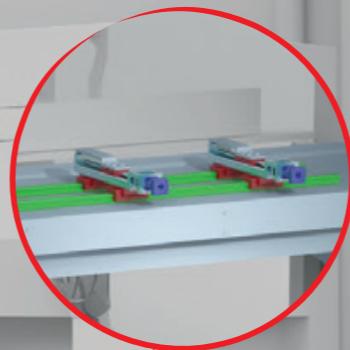

> X-Y Achse von Laserschneidanlagen  
X-Y axes of laser machine

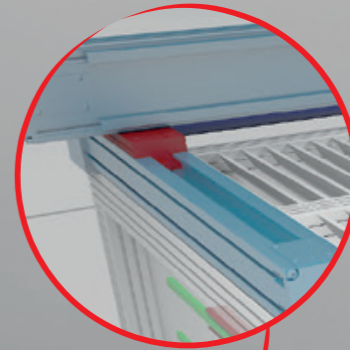

> Schubladenauszug  
Drawer extraction

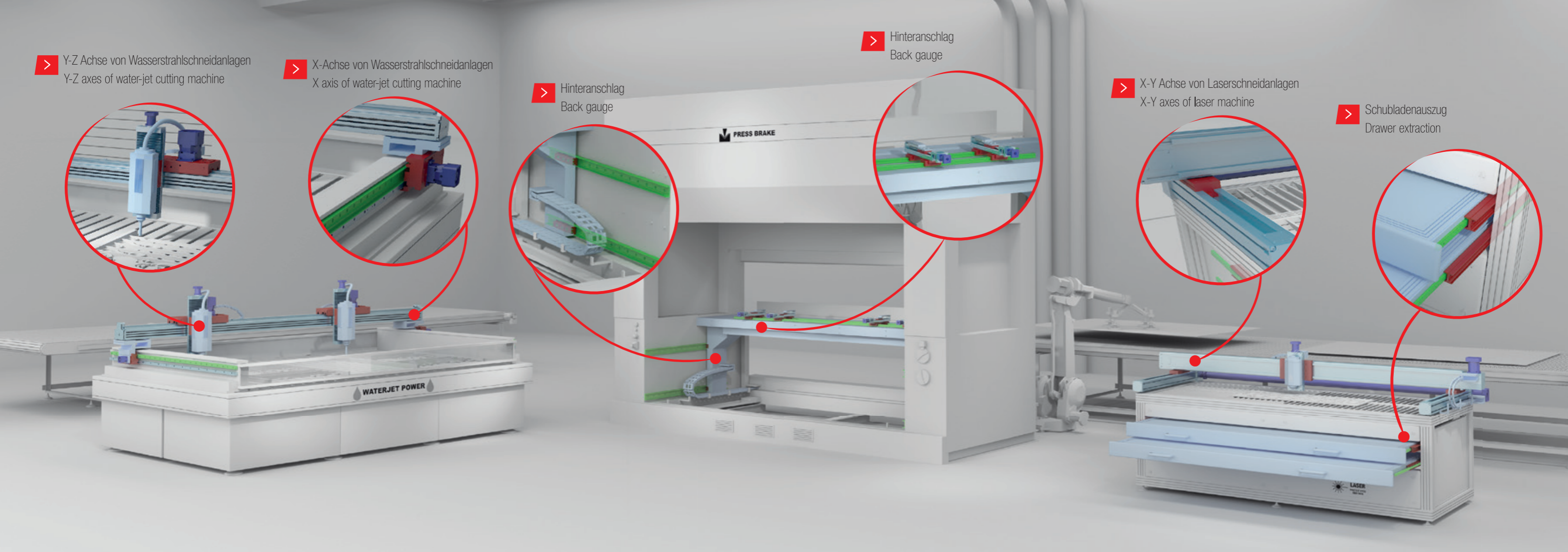
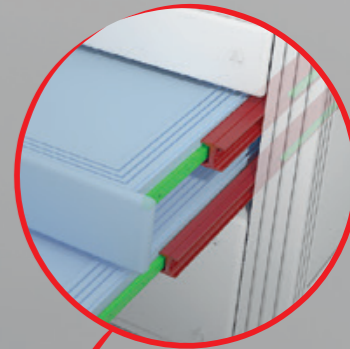

> Z-Achse von Marmor Gravieranlagen  
Z axis of Machine engraving on marble

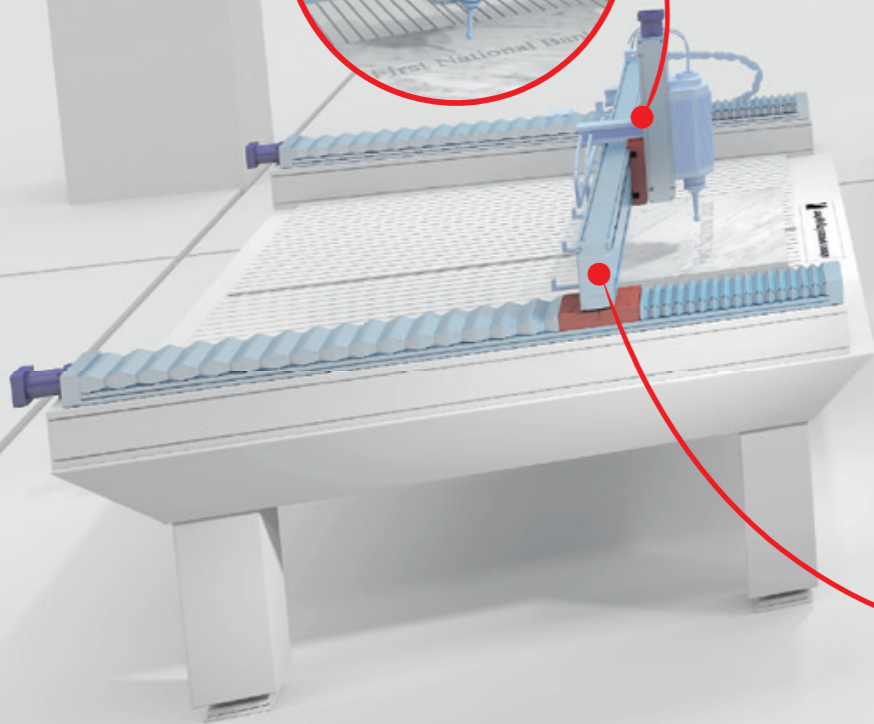
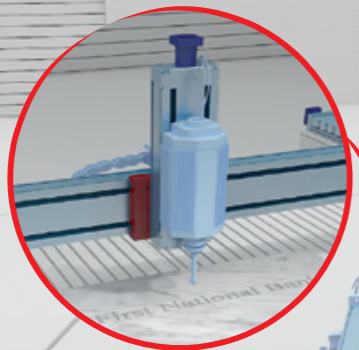

> X-Y Achse von Marmor Gravieranlagen  
X-Y axes of Machine engraving marble

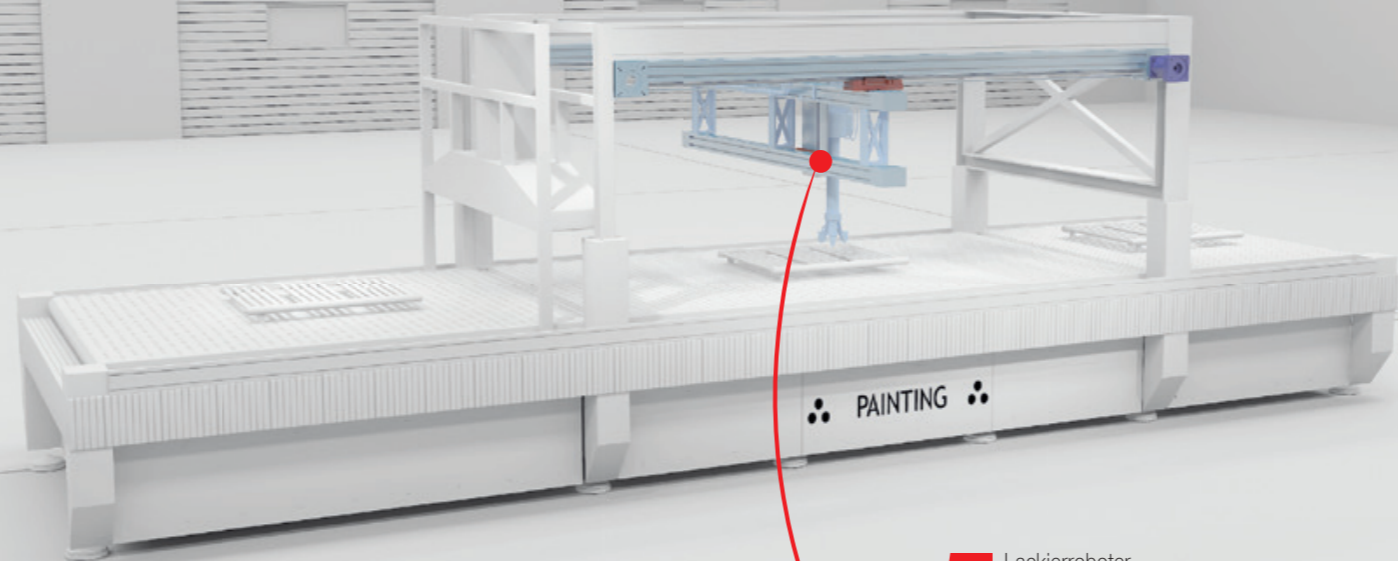
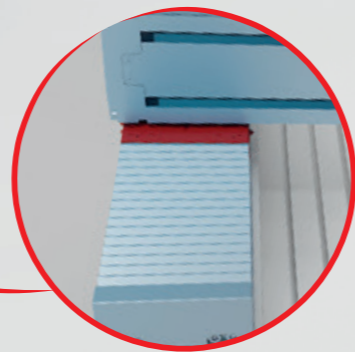

> Lackierroboter  
Painting robot

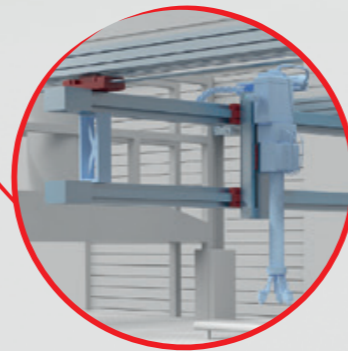

> Plotter  
Die cutter

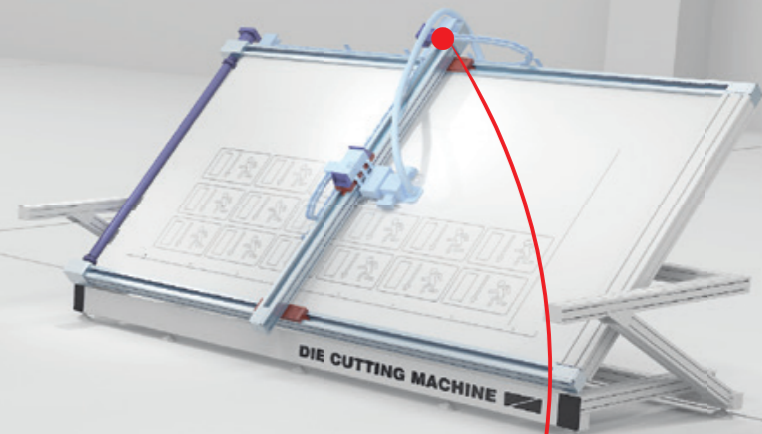
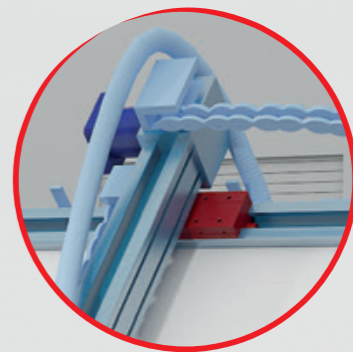



> Maschinenwerkzeug Öffnungsklappe  
Machine tool opening door

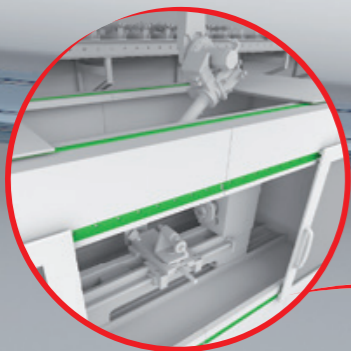

> Siebte Achse zum Ein- und Ausladen der Maschinen  
Seventh axis for machines loading and unloading

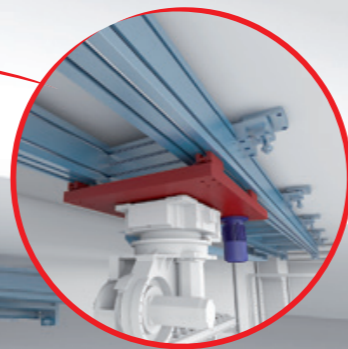

> Siebte Achse zum Ein- und Ausladen der Presse  
Seventh axis for press loading and unloading

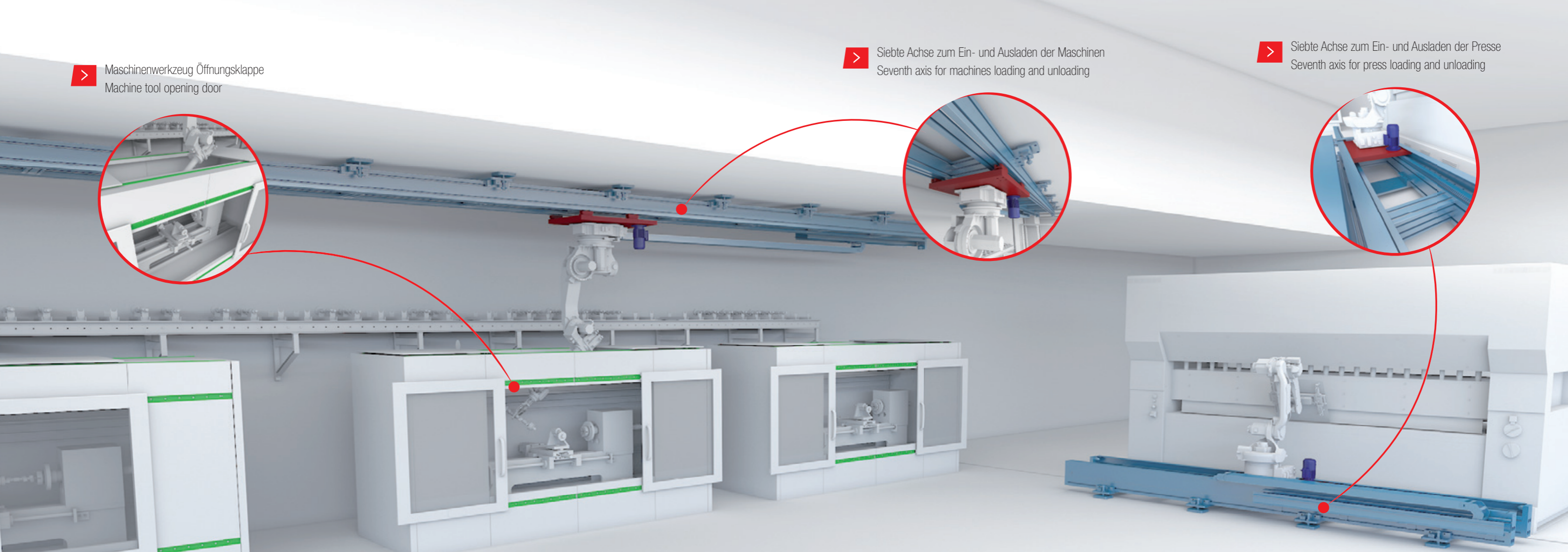

> Siebte Achse für Klebe Roboter  
Seventh axis for gluing robot



> Z-Achse Heben und Bewegen Verkettungssysteme  
Z axis of lift and move system

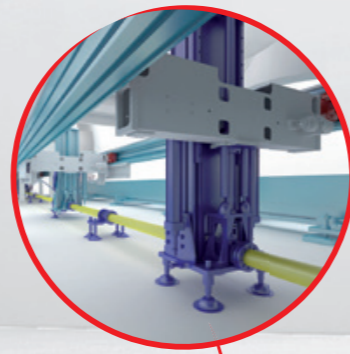

> Siebte Achse für Lackier Roboter  
Seventh axis for painting robot

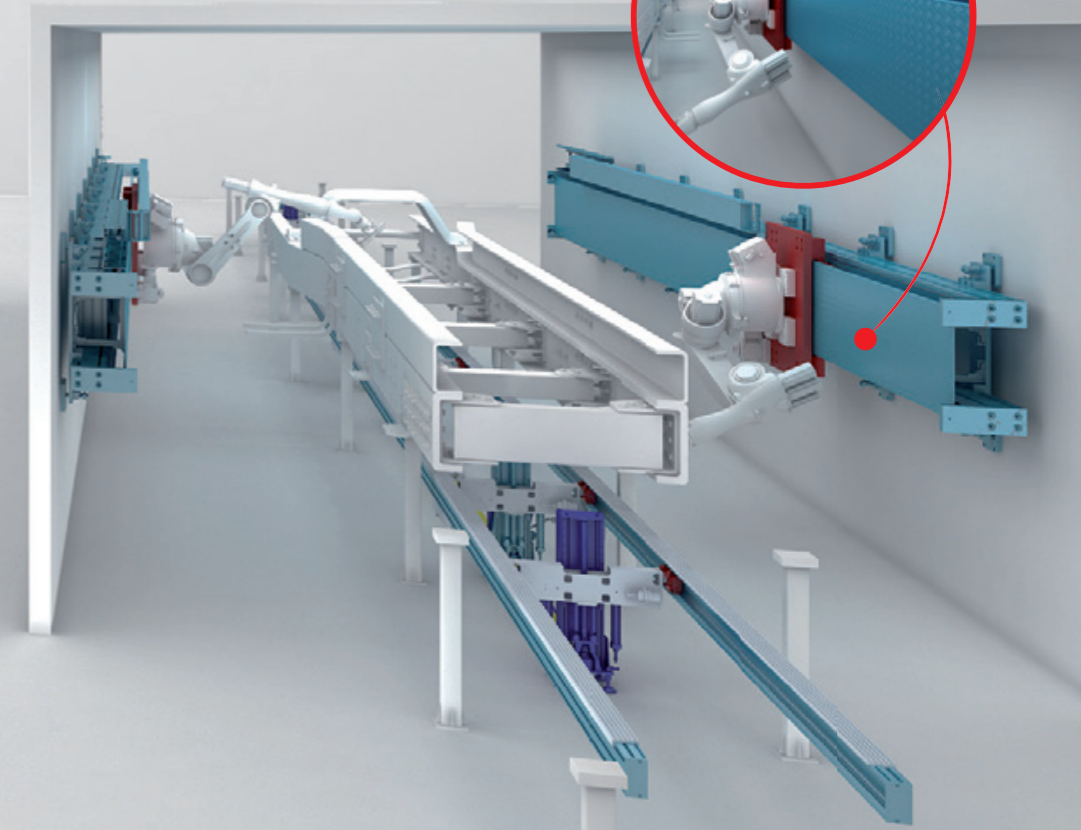
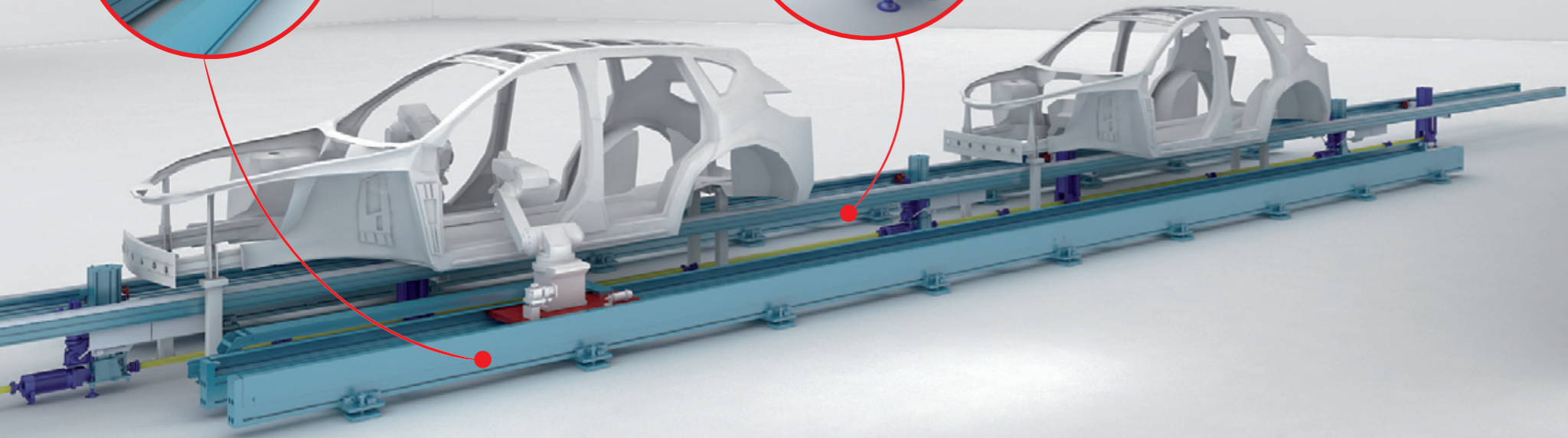
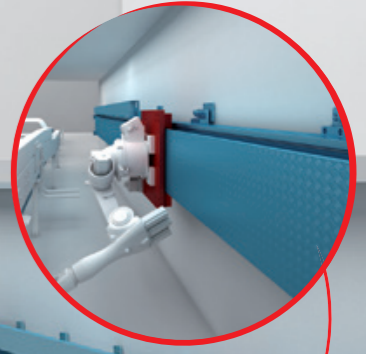



> X-Y Achse für Keramik Bearbeitungsmaschinen  
X-Y axes of ceramic working machine

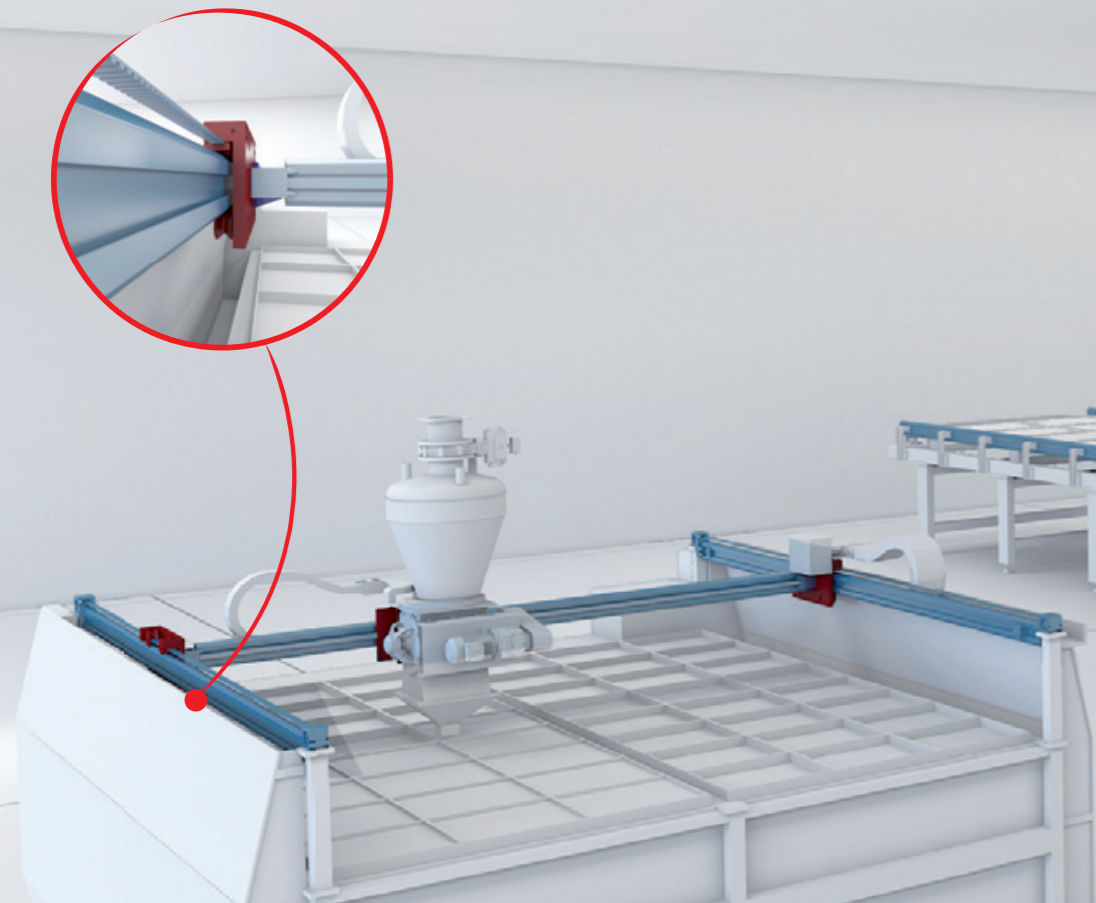

> Be- und Entladen von Holz Bearbeitungsmaschinen  
Loading and unloading of wood working machine

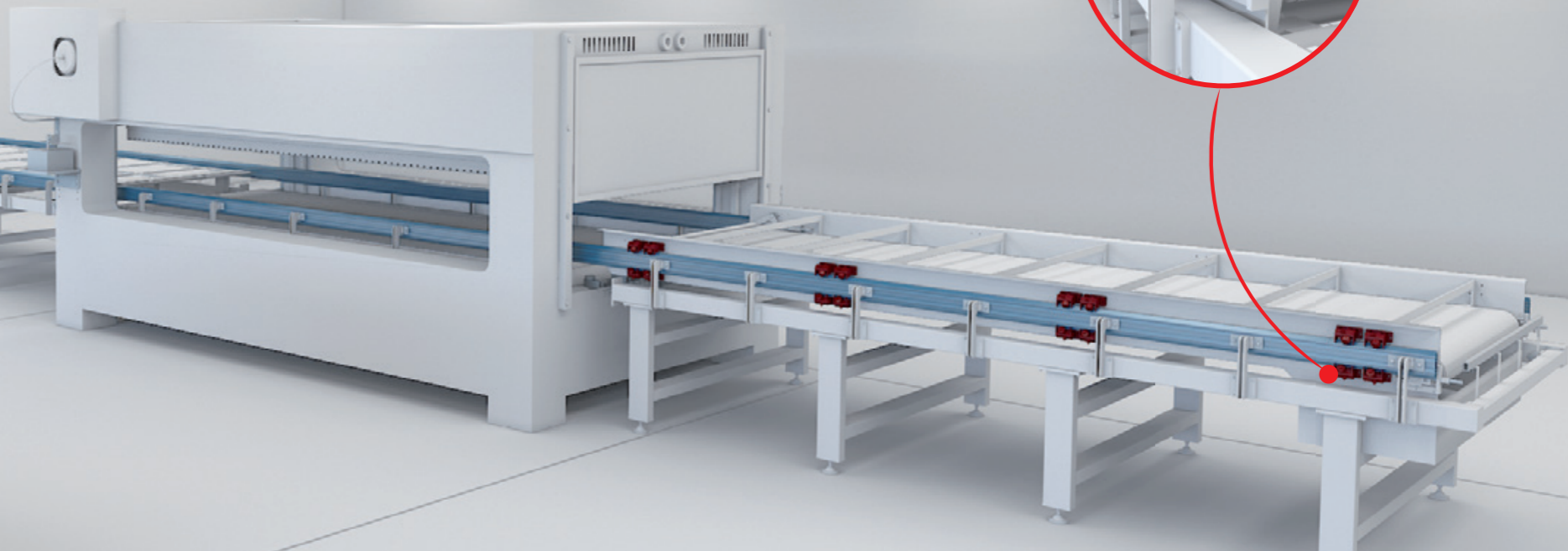



> Drahtgitter schweißen  
Wire mesh welding

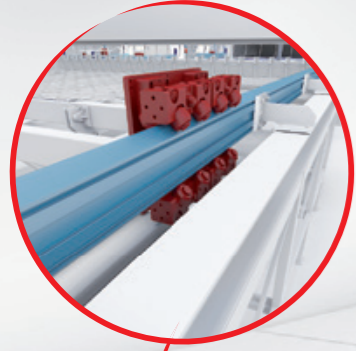

> Drahtgitter schweißen  
Wire mesh welding

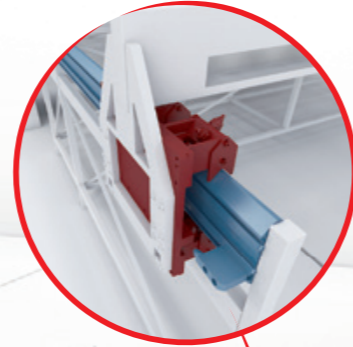

> X-Y Achse zum Be- und Entladen von Werkstücken  
X-Y axes of loading and unloading of machined pieces

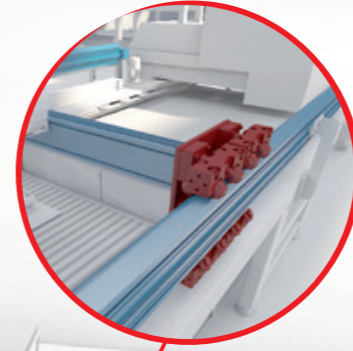

> Z-Achse zum Be- und Entladen von Werkstücken  
Z axis of loading and unloading of machined pieces

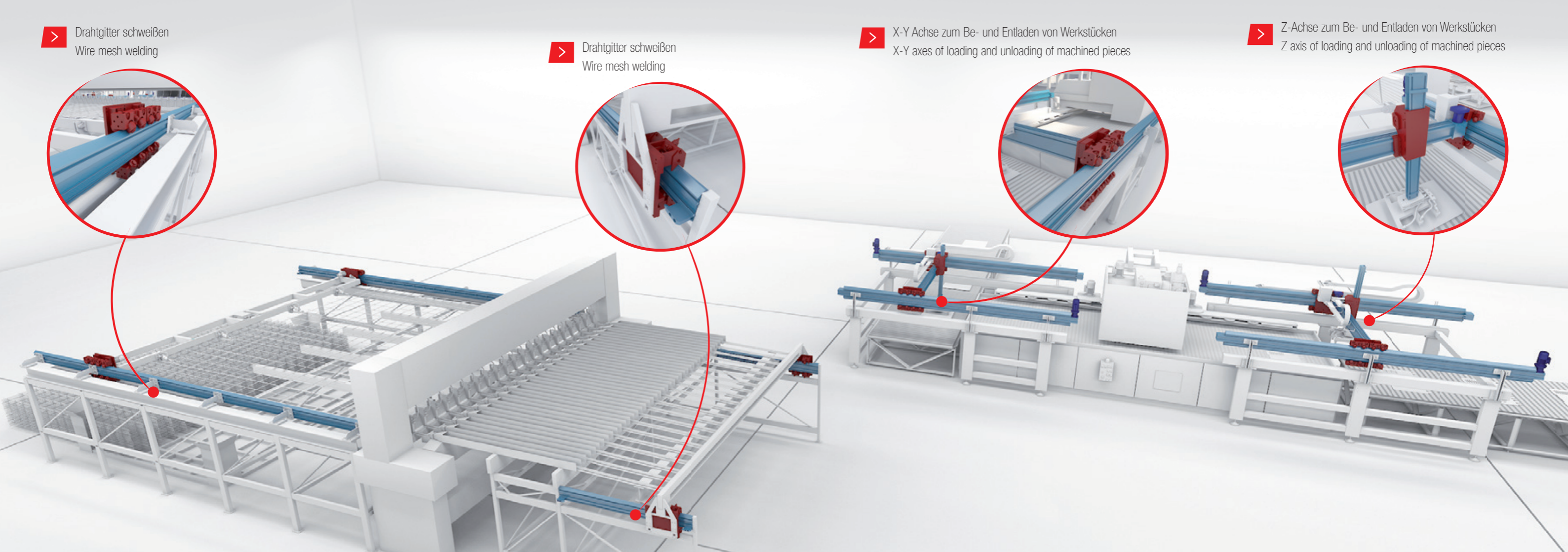
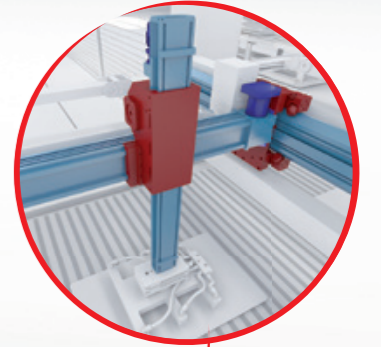



> Lackiermaschinen  
Painting machines

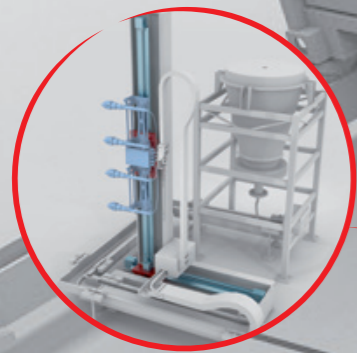

> Siebte Achse für Schweiß Roboter  
Seventh axis for welding robot

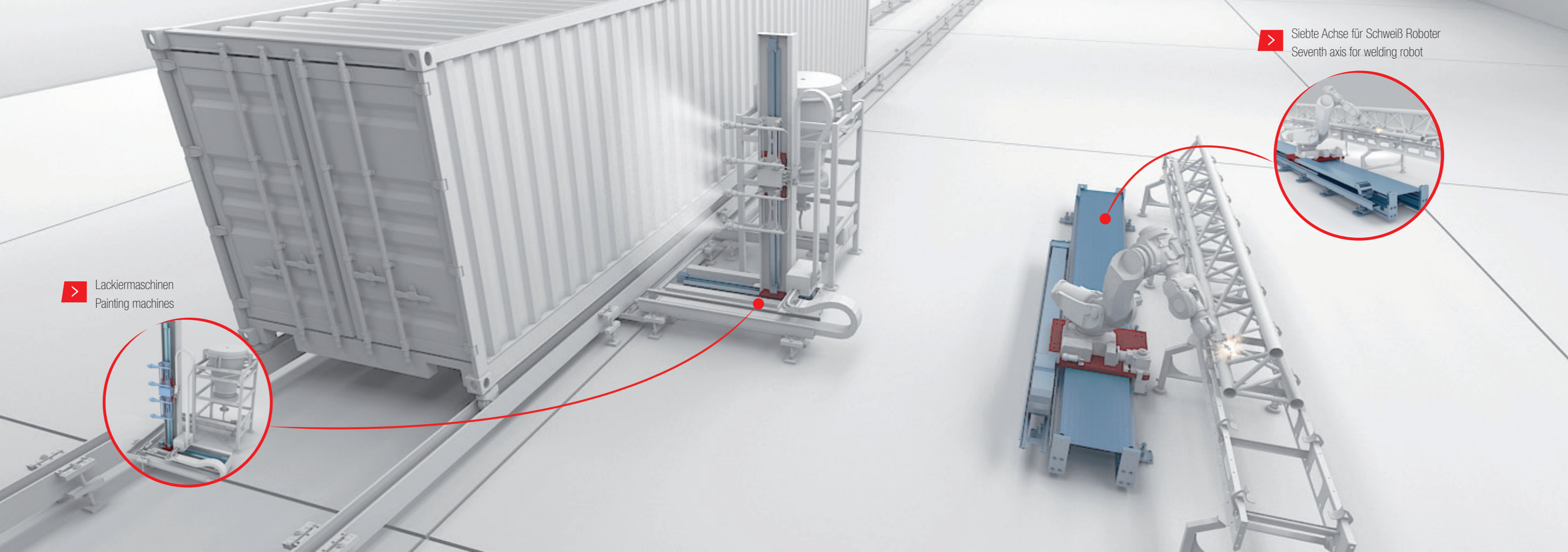
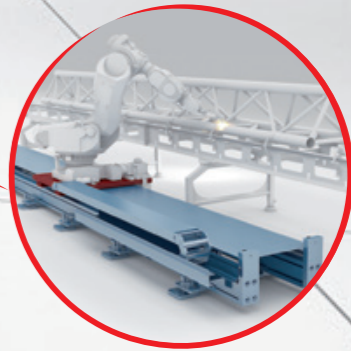





Linear- und Bogenführungen mit Kugel- und Rollenlager.  
Linear and curved guides with ball and roller bearings.

**Linear Line**

**Ein Komplettangebot  
der Lineartechnik, das jeden  
Kunden erreicht**

**A complete range for linear motion  
which reaches every customer**

**Ein weltweiter Anbieter  
anwendungsspezifischer  
Lösungen**  
**A global provider  
of solutions for applications  
for linear motion**

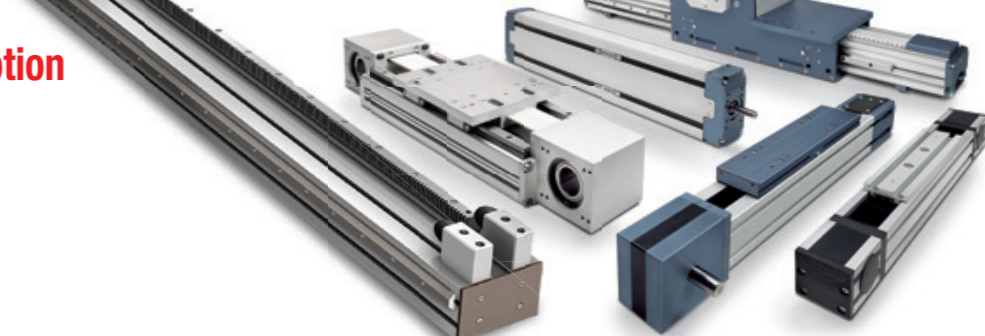

Linearantriebe Mit verschiedenen Konfigurationen der  
Führungsschienen und Antriebe.  
Linear actuators with different guide configurations and drives.

**Actuator Line**



**Actuator System Line**

Spezielle Mehrachsensysteme zur industriellen Automatisierung.  
Special multiple axis systems for industrial automation.

**Telescopic Line**

Teleskopschienen mit Kugellager  
Telescopic guides with ball bearings







- Rollon Niederlassungen & Vertretungen
- Vertriebspartner

## EUROPE

### ROLLON S.p.A. - ITALY (Headquarters)



Via Trieste 26  
I-20871 Vimercate (MB)  
Phone: (+39) 039 62 59 1  
www.rollon.it - infocom@rollon.it

### ROLLON GmbH - GERMANY



Bonner Strasse 317-319  
D-40589 Düsseldorf  
Phone: (+49) 211 95 747 0  
www.rollon.de - info@rollon.de

### ROLLON S.A.R.L. - FRANCE



Les Jardins d'Eole, 2 allée des Séquoias  
F-69760 Limonest  
Phone: (+33) (0) 4 74 71 93 30  
www.rollon.fr - infocom@rollon.fr

### ROLLON B.V. - NETHERLANDS



Ringbaan Zuid 8  
6905 DB Zevenaar  
Phone: (+31) 316 581 999  
www.rollon.nl - info@rollon.nl

### ROLLON S.p.A. - RUSSIA (Rep. Office)



117105, Moscow, Varshavskoye  
shosse 17, building 1  
Phone: +7 (495) 508-10-70  
www.rollon.ru - info@rollon.ru

### ROLLON Ltd - UK (Rep. Office)



The Works 6 West Street Olney  
Buckinghamshire, United Kingdom, MK46 5 HR  
Phone: +44 (0) 1234964024  
www.rollon.uk.com - info@rollon.uk.com

## AMERICA

### ROLLON Corporation - USA



101 Bilby Road, Suite B  
Hackettstown, NJ 07840  
Phone: (+1) 973 300 5492  
www.rolloncorp.com - info@rolloncorp.com

### ROLLON - SOUTH AMERICA (Rep. Office)



R. Joaquim Floriano, 397, 2o. andar  
Itaim Bibi - 04534-011, São Paulo, BRASIL  
Phone: +55 (11) 3198 3645  
www.rollonbrasil.com.br - info@rollonbrasil.com

## ASIA

### ROLLON Ltd - CHINA



No. 1155 Pang Jin Road,  
China, Suzhou, 215200  
Phone: +86 0512 6392 1625  
www.rollon.cn.com - info@rollon.cn.com

### ROLLON India Pvt. Ltd. - INDIA



1st floor, Regus Gem Business Centre, 26/1  
Hosur Road, Bommanahalli, Bangalore 560068  
Phone: (+91) 80 67027066  
www.rollonindia.in - info@rollonindia.in

### ROLLON - JAPAN



3F Shiodome Building, 1-2-20 Kaigan, Minato-ku,  
Tokyo 105-0022 Japan  
Phone +81 3 6721 8487  
www.rollon.jp - info@rollon.jp