

ROLLON®

BY TIMKEN

Linear Line

Telescopic Line

Actuator Line

Actuator System Line



Solutions linéaires pour véhicules spéciaux
Linear solutions for special vehicles applications

**Avec vous. En mouvement.
When you move, we move**

Acteur incontournable, ROLLON s'est spécialisé depuis 1975 sur le marché des solutions linéaires, concevant et fabriquant des guidages linéaires, des glissières télescopiques et des unités linéaires. Grâce à un savoir-faire et une expérience reconnus, ROLLON propose des solutions innovantes qui peuvent s'adapter sur-mesure à votre projet en fonction de vos besoins spécifiques.

ROLLON has been a leading international linear motion manufacturer since 1975 providing linear bearings, actuators and linear motion products that surpass the needs of its industrial customer base. ROLLON's family of products provides high quality, cost-effective answers to standardized industry requirements. The biggest added value is given by the ability to personalize the product according to the application so that if needed, the product becomes "unique for each customer".

ROLLON[®]
BY TIMKEN

> Réglage de siège
Seat Adjustment
Extraction de tiroir
Drawer Slide Out

> Porte coulissante
Sliding door

> Système d'ouverture pour carter de moteur
Engine cover opening system

> Machines pour le travail du marbre
Marble drilling machines

> Extension de toit
Roof expansion

> Réglage de siège et panneau de commande
des mouvements
Seat adjustment and control board movement

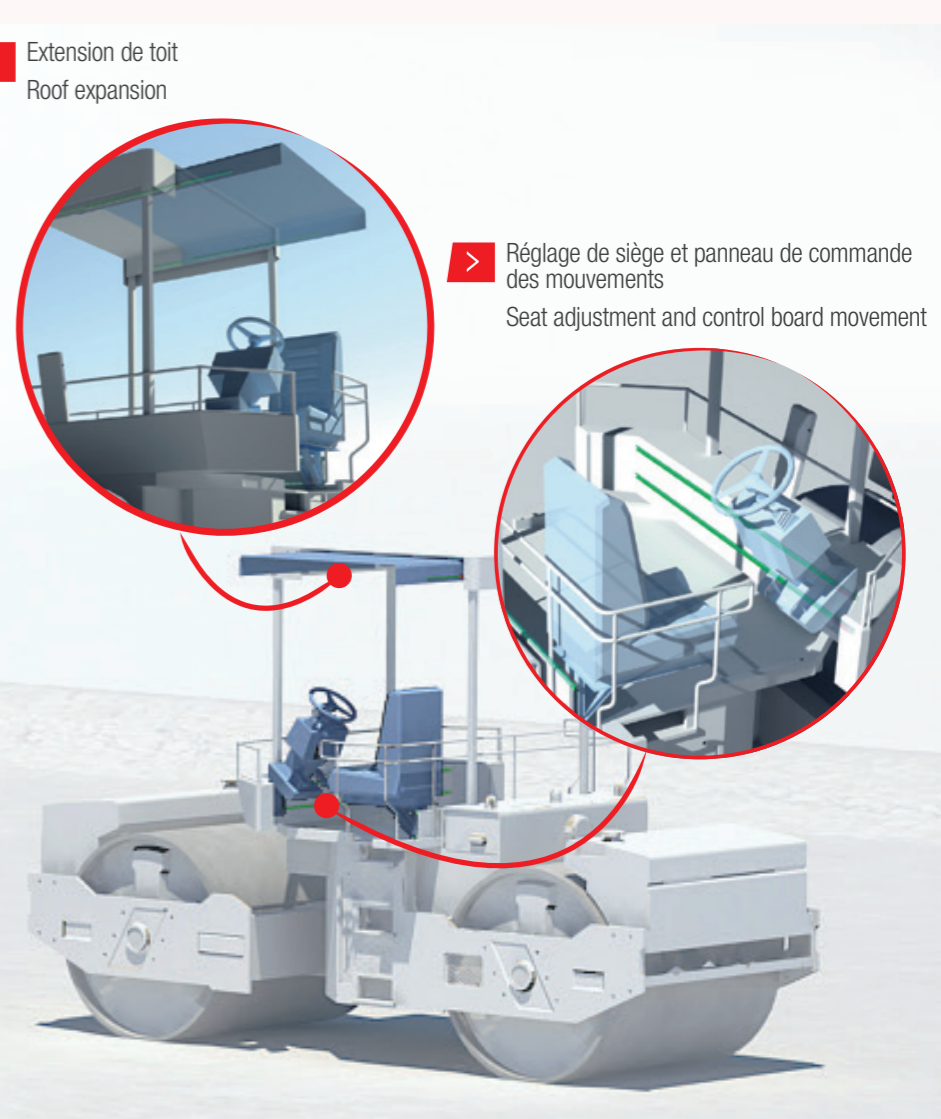
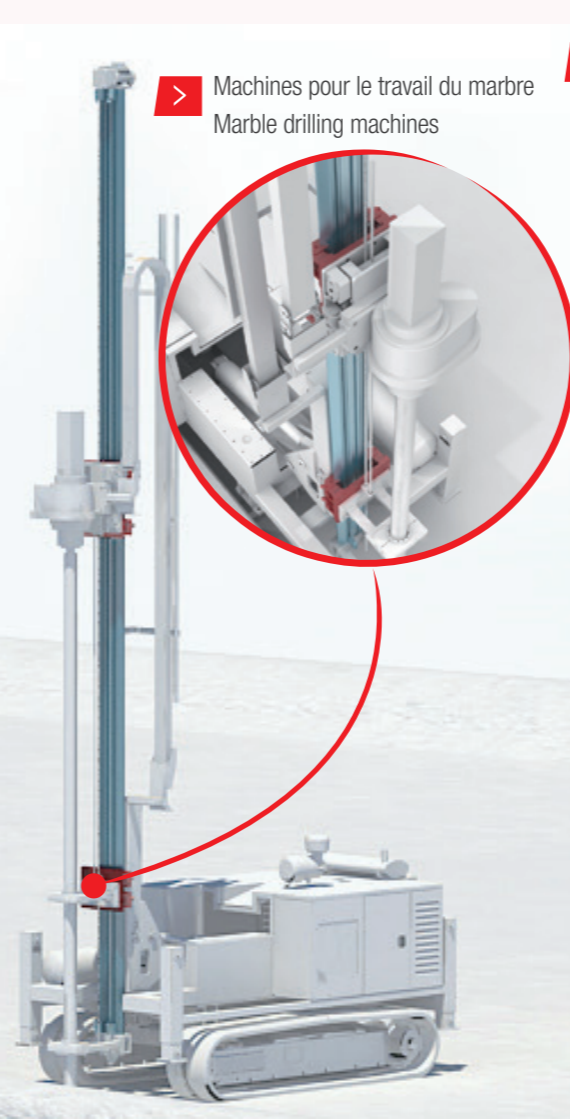
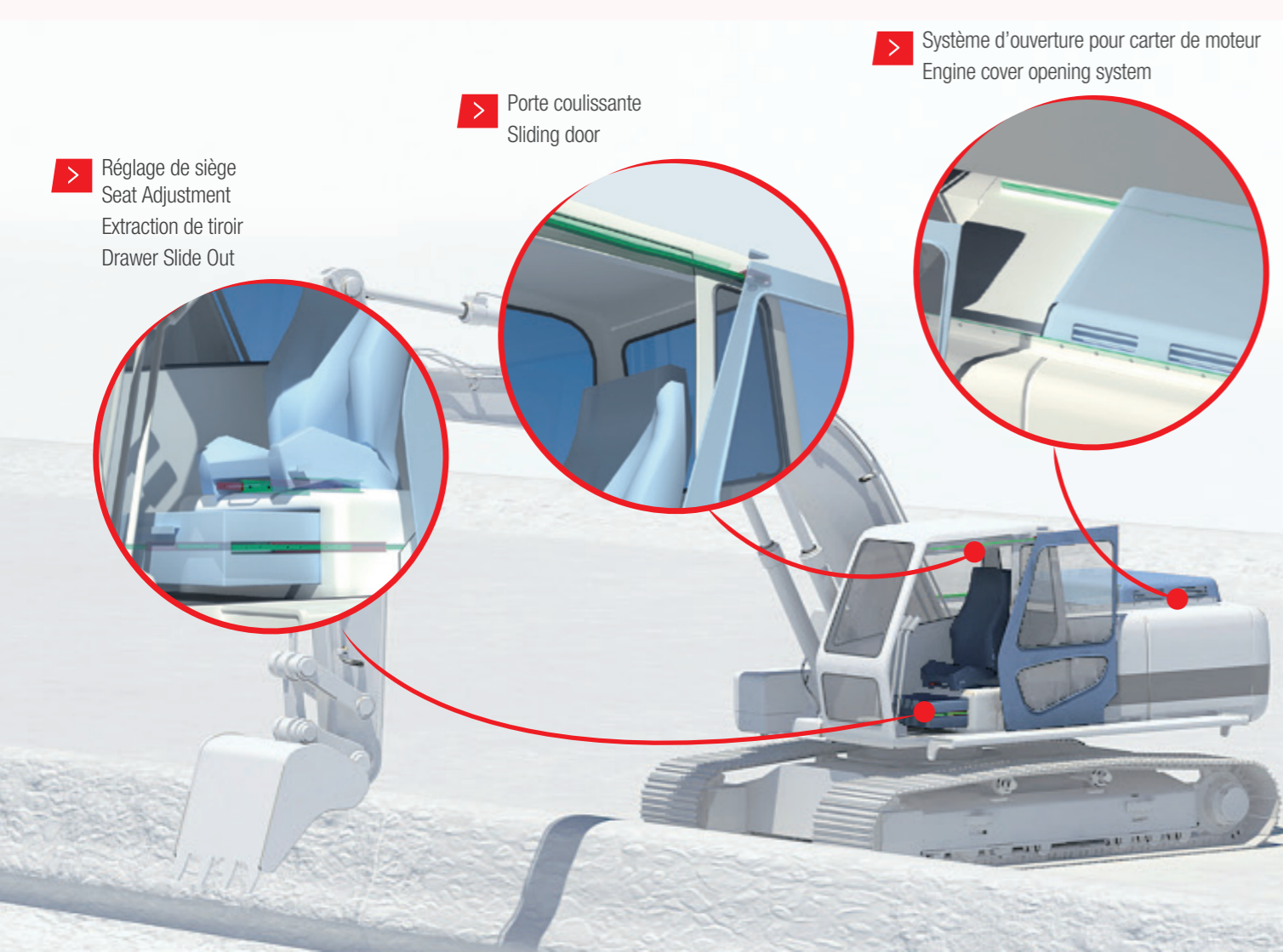
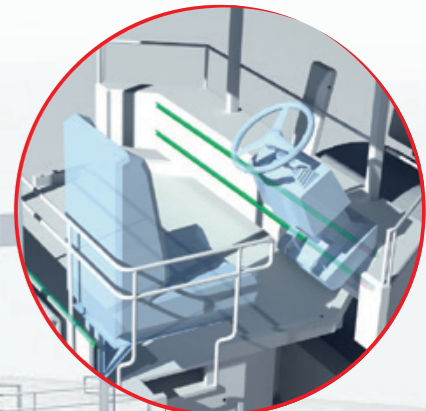
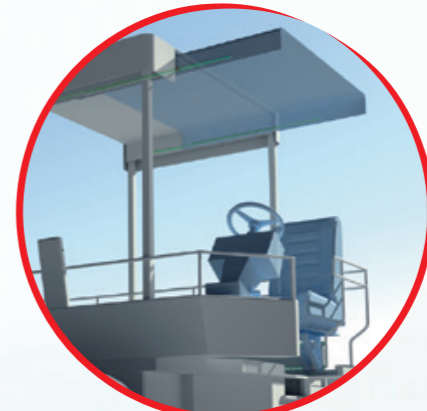
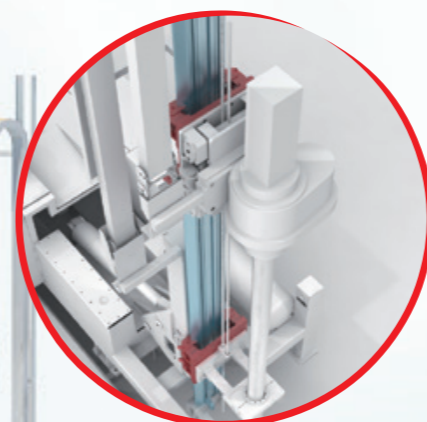
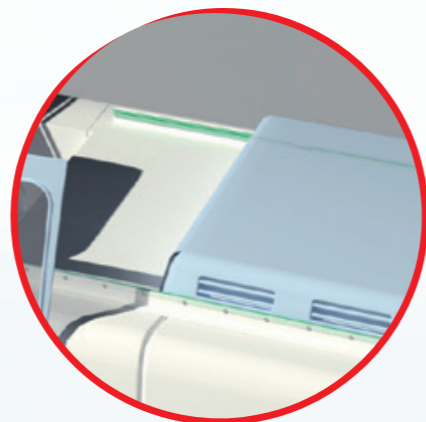
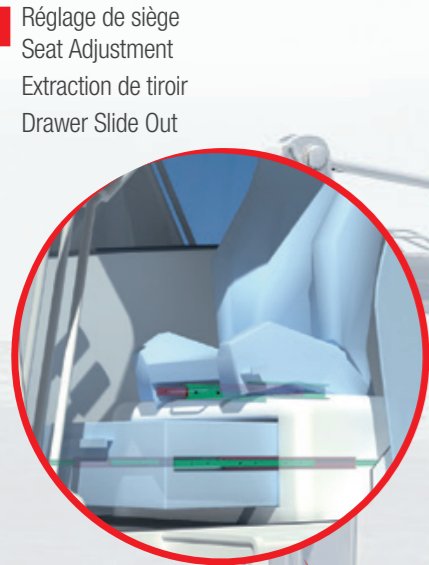

> Rampe d'accès pour personnes à mobilité réduite
Access ramp for disabled

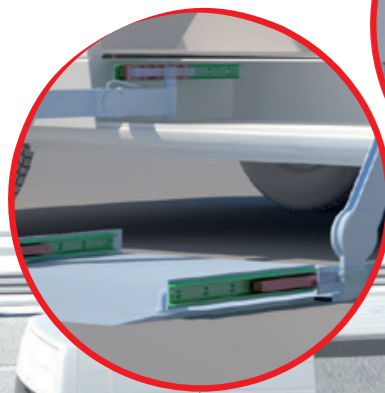

> Glissière pour pompe de secours
Emergency pump slide out

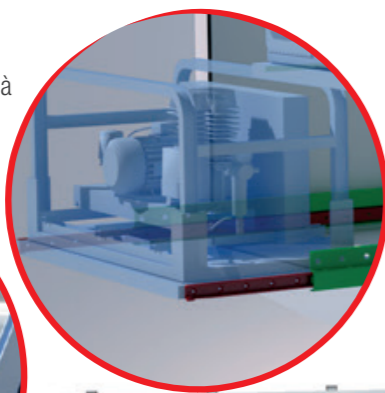

> Extraction de générateur
Power generator extraction

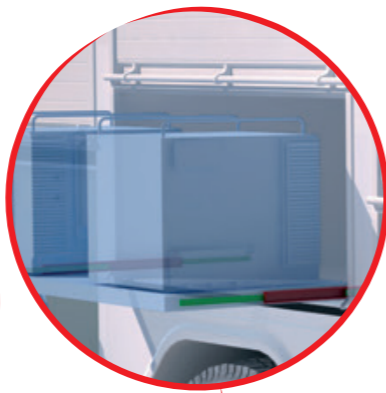

> Extraction de coffre à outils
Tool slide out

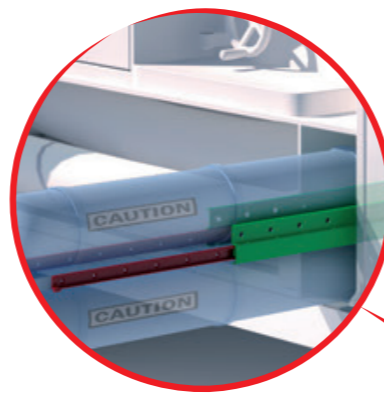

> Système d'extraction de civière
Stretcher Slider Out

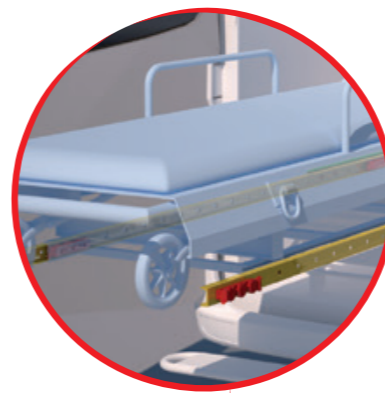

> Table coulissante
Sliding table

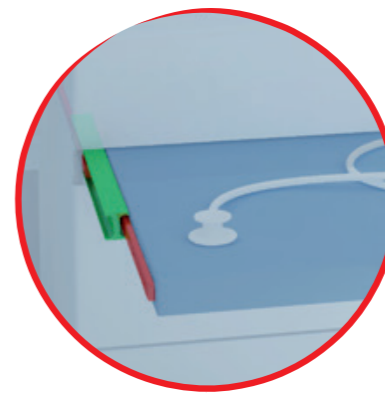

> Réglage d'écran LCD
LCD screen adjustment



> Vitrine coulissante
Display slide out

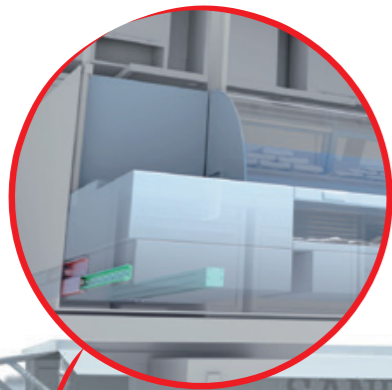

> Tiroir intérieur
Interior drawers

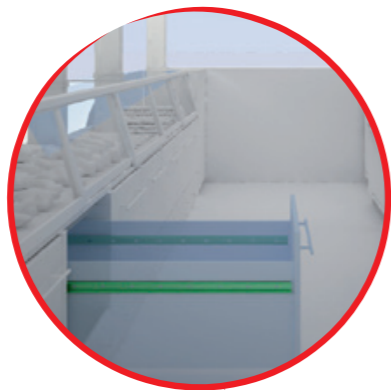

> Système d'ouverture de porte
Opening door system

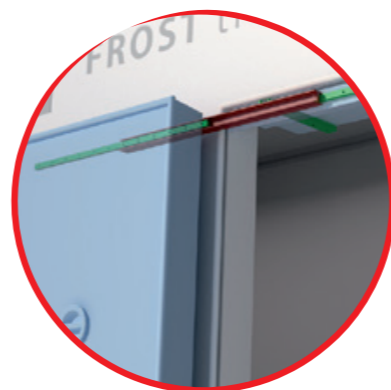

> Extension de remorque
Trailer expansion

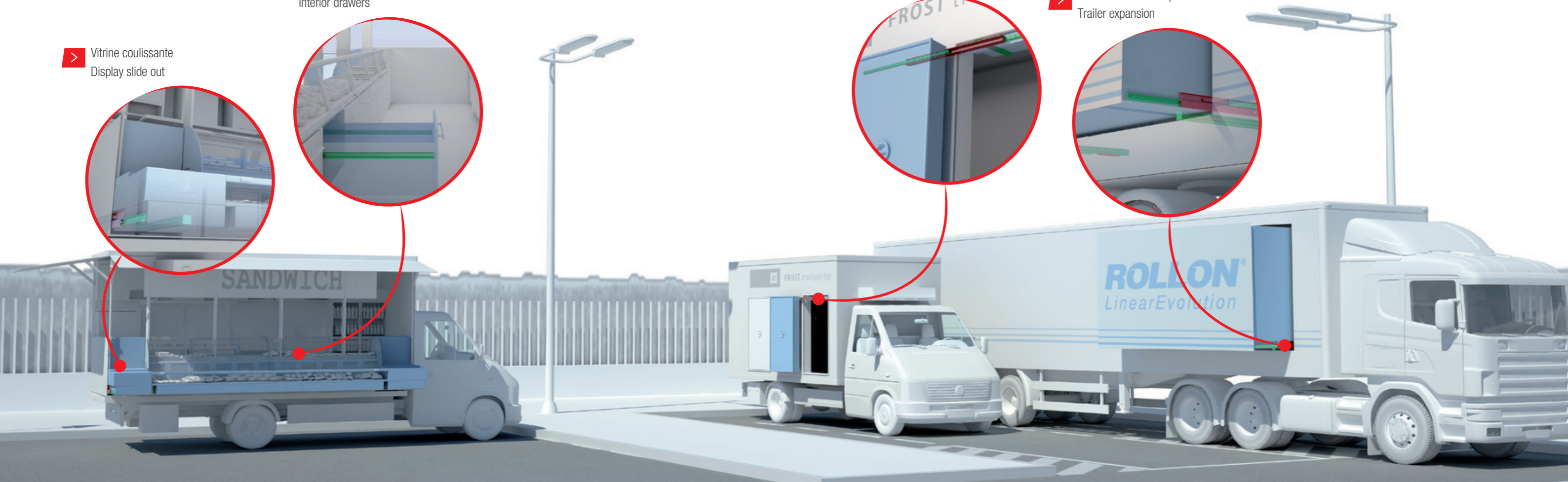
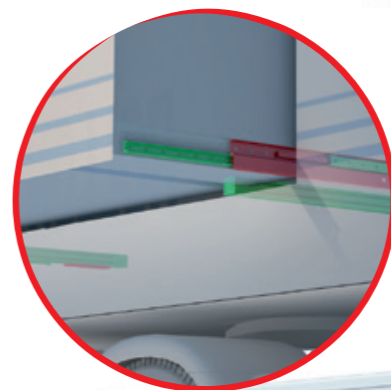

> Extension de plateforme
Platform extension

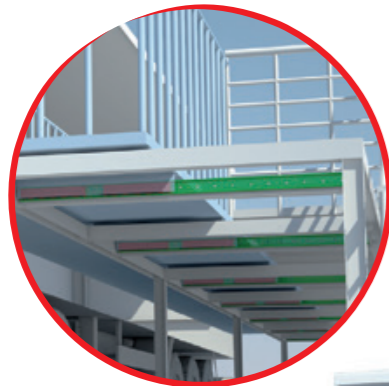

> Manipulation de tuyau
Pipe handling

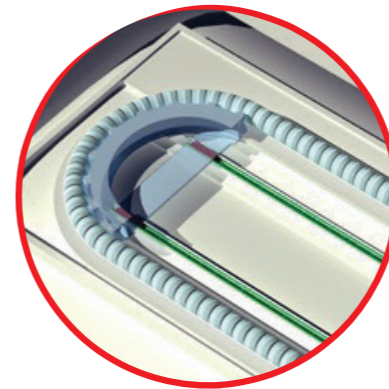

> Mouvement de la tête d'arrosage
Sprinkler head movement

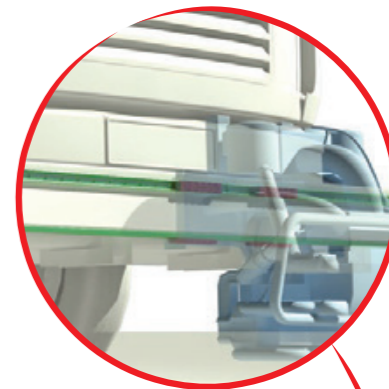



Guidages linéaires et courbes à billes et à galets.
Linear and curved guides with ball and roller bearings.

Linear Line

Telescopic Line

Glissières télescopiques à billes
Telescopic guides with ball bearings

Une gamme complète pour le mouvement linéaire qui satisfait chaque client

A complete range for linear motion which reaches every customer

Fournisseur mondial de solutions linéaires
A global provider of solutions for applications for linear motion

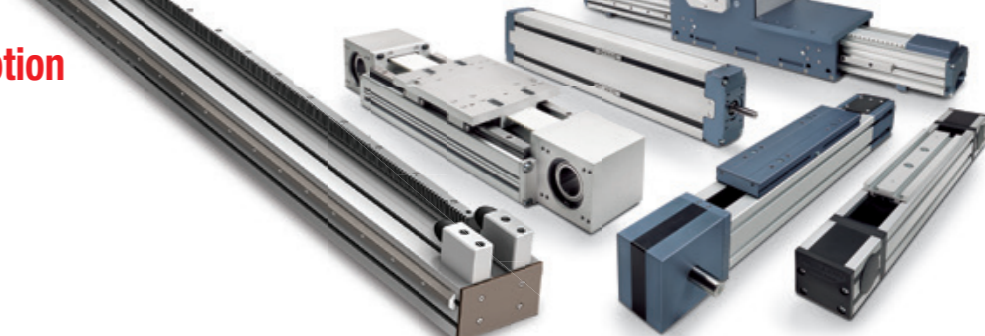

Axes linéaires avec différents types de guidage et différents modes d'entraînement.
Linear actuators with different guide configurations and drives.

Actuator Line



Actuator System Line

Systèmes spéciaux multi-axes pour l'automatisation industrielle.
Special multiple axis systems for industrial automation.



● Filiales et bureaux commerciaux ● Distributeurs

EUROPE

ROLLON S.p.A. - ITALY (Headquarters)

Via Trieste 26
I-20871 Vimercate (MB)
Phone: (+39) 039 62 59 1
www.rollon.it - infocom@rollon.it

ROLLON GmbH - GERMANY

Bonner Strasse 317-319
D-40589 Düsseldorf
Phone: (+49) 211 95 747 0
www.rollon.de - info@rollon.de

ROLLON S.A.R.L. - FRANCE

Les Jardins d'Eole, 2 allée des Séquoias
F-69760 Limonest
Phone: (+33) (0) 4 74 71 93 30
www.rollon.fr - infocom@rollon.fr

ROLLON B.V. - NETHERLANDS

Ringbaan Zuid 8
6905 DB Zevenaar
Phone: (+31) 316 581 999
www.rollon.nl - info@rollon.nl

ROLLON S.p.A. - RUSSIA (Rep. Office)

117105, Moscow, Varshavskoye
shosse 17, building 1
Phone: +7 (495) 508-10-70
www.rollon.ru - info@rollon.ru

ROLLON Ltd - UK (Rep. Office)

The Works 6 West Street Olney
Buckinghamshire, United Kingdom, MK46 5 HR
Phone: +44 (0) 1234964024
www.rollon.uk.com - info@rollon.uk.com

AMERICA

ROLLON Corporation - USA

101 Bilby Road, Suite B
Hackettstown, NJ 07840
Phone: (+1) 973 300 5492
www.rolloncorp.com - info@rolloncorp.com

ROLLON - SOUTH AMERICA (Rep. Office)

R. Joaquim Floriano, 397, 2o. andar
Itaim Bibi - 04534-011, São Paulo, BRASIL
Phone: +55 (11) 3198 3645
www.rollonbrasil.com.br - info@rollonbrasil.com

ASIA

ROLLON Ltd - CHINA

No. 1155 Pang Jin Road,
China, Suzhou, 215200
Phone: +86 0512 6392 1625
www.rollon.cn.com - info@rollon.cn.com

ROLLON India Pvt. Ltd. - INDIA

1st floor, Regus Gem Business Centre, 26/1
Hosur Road, Bommanahalli, Bangalore 560068
Phone: (+91) 80 67027066
www.rollonindia.in - info@rollonindia.in

ROLLON - JAPAN

3F Shiodome Building, 1-2-20 Kaigan, Minato-ku,
Tokyo 105-0022 Japan
Phone +81 3 6721 8487
www.rollon.jp - info@rollon.jp