

ROLLON®

BY TIMKEN

Linear Line

Telescopic Line

Actuator Line

Actuator System Line

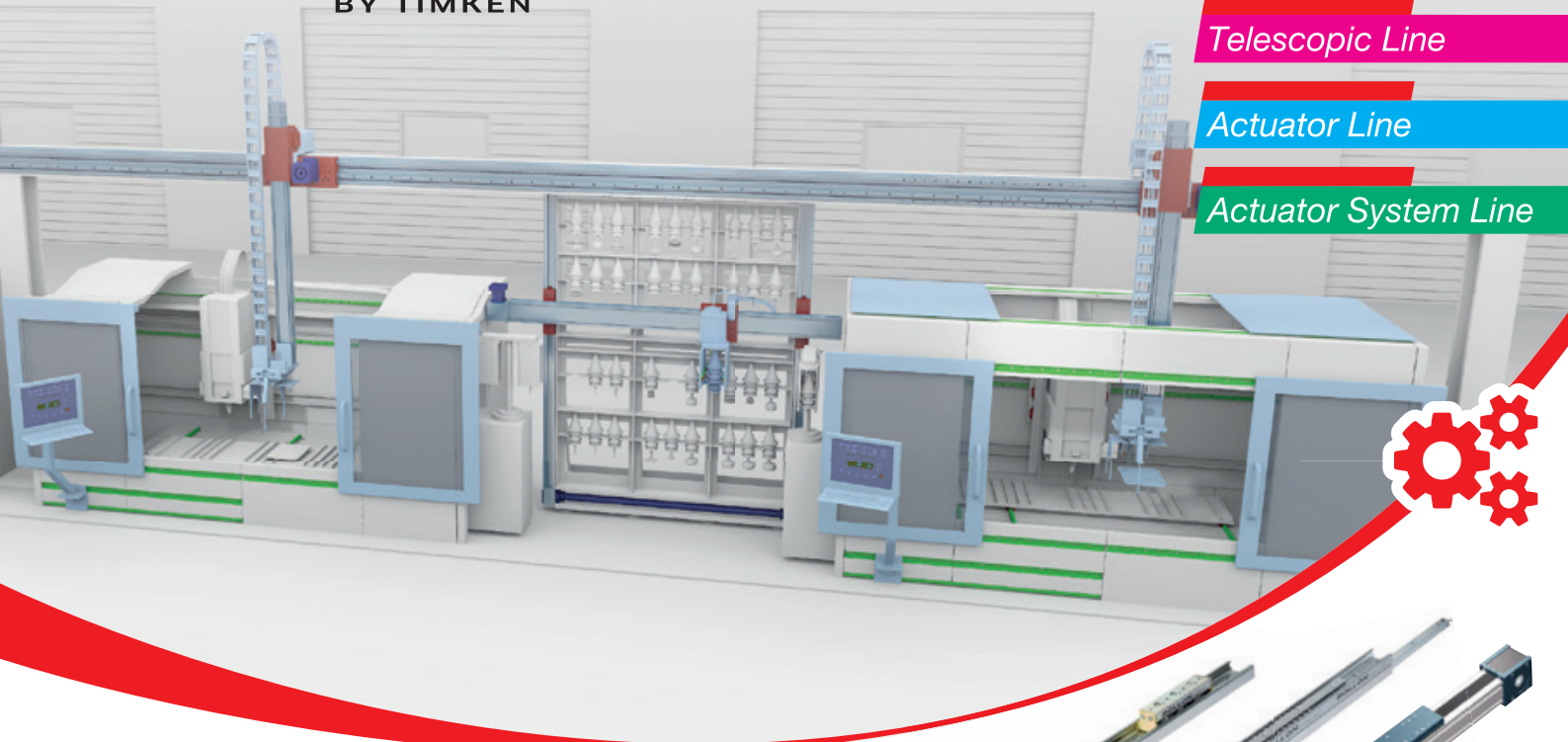

Solutions linéaires pour machines industrielles
Linear solutions for industrial machines

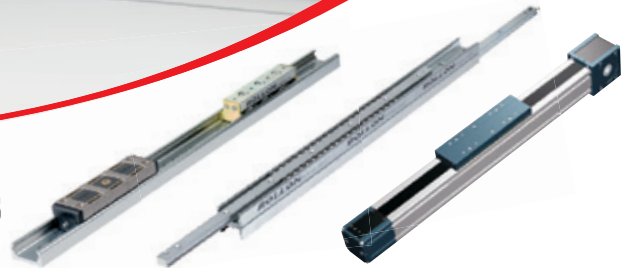

**Avec vous. En mouvement.
When you move, we move**

Acteur incontournable, ROLLON s'est spécialisé depuis 1975 sur le marché des solutions linéaires, concevant et fabriquant des guidages linéaires, des glissières télescopiques et des unités linéaires. Grâce à un savoir-faire et une expérience reconnus, ROLLON propose des solutions innovantes qui peuvent s'adapter sur-mesure à votre projet en fonction de vos besoins spécifiques.

ROLLON has been a leading international linear motion manufacturer since 1975 providing linear bearings, actuators and linear motion products that surpass the needs of its industrial customer base. ROLLON's family of products provides high quality, cost-effective answers to standardized industry requirements. The biggest added value is given by the ability to personalize the product according to the application so that if needed, the product becomes "unique for each customer".

ROLLON[®]
BY TIMKEN

> Porte automatique pour machine outils
Automated Machine Tool Doors

> Chargement et déchargement de pièces usinées
Loading & unloading of the machined piece

> Ouverture de tiroir
Drawer extraction

> Porte pour machine outils
Machine tool opening door

> Robot chargeur d'outils
Tool changer robot

> Écran de contrôle coulissant
Screen sliding

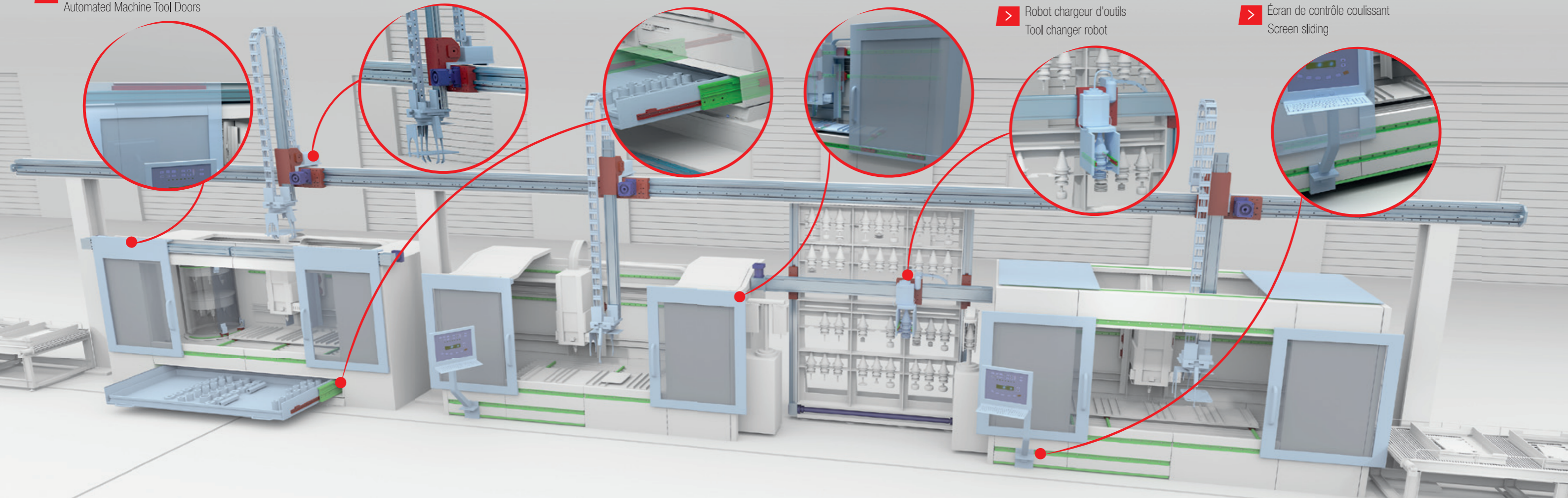

> Axes Y-Z pour machine de découpe jet d'eau
Y-Z axes of water-jet cutting machine

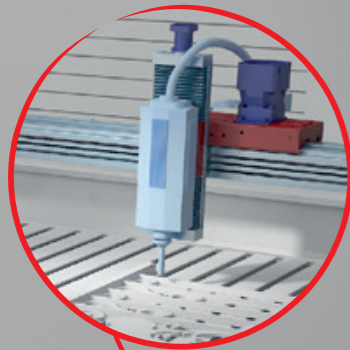

> Axe X pour machine de découpe jet d'eau
X axis of water-jet cutting machine

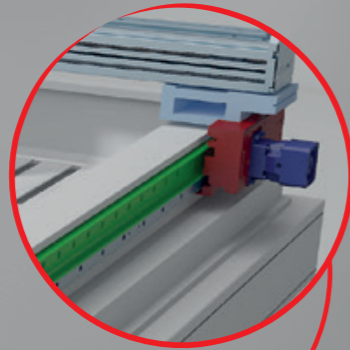

> Butée arrière
Back gauge

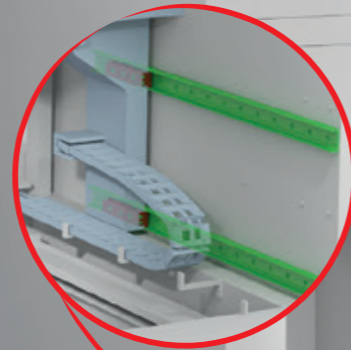

> Butée arrière
Back gauge

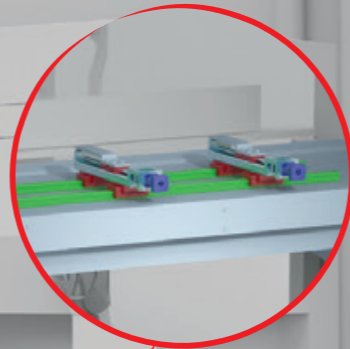

> Axes X-Y pour machine de découpe laser
X-Y axes of laser machine

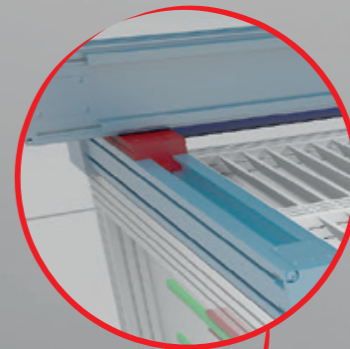

> Ouverture de tiroir
Drawer extraction

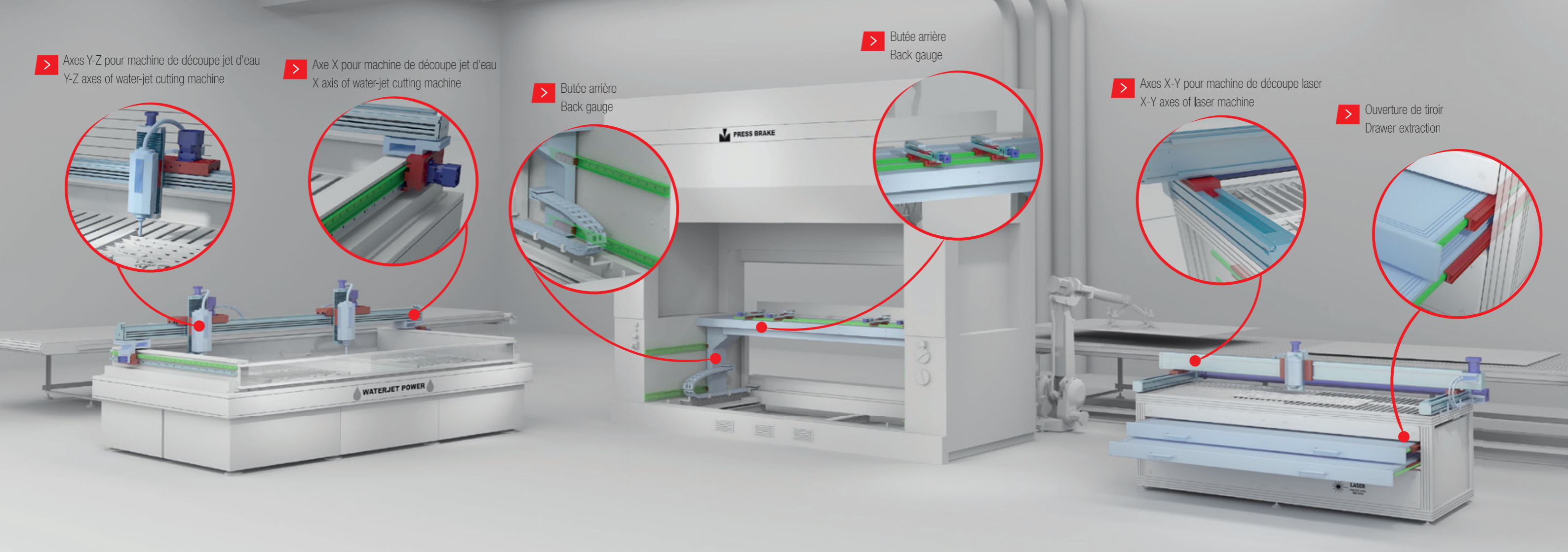
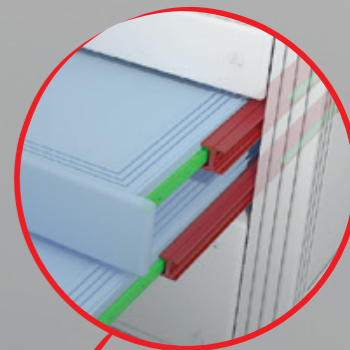

> Axe Z pour machine à graver le marbre
Z axis of Machine engraving on marble

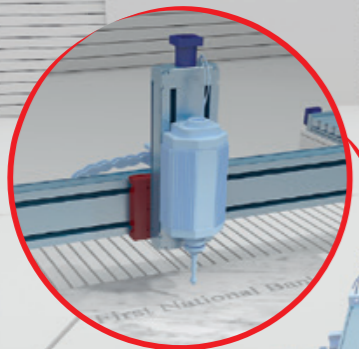

> Axes X-Y pour machine à graver le marbre
X-Y axes of Machine engraving marble

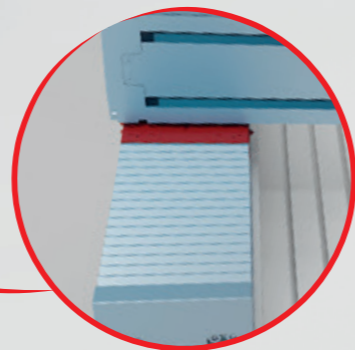

•• PAINTING ••

> Robot de peinture
Painting robot

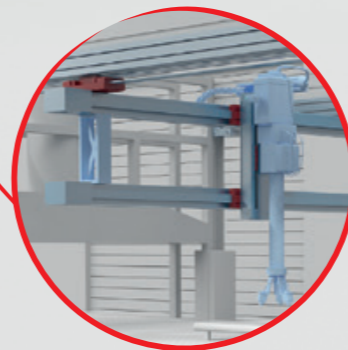

> Outil de découpe
Die cutter

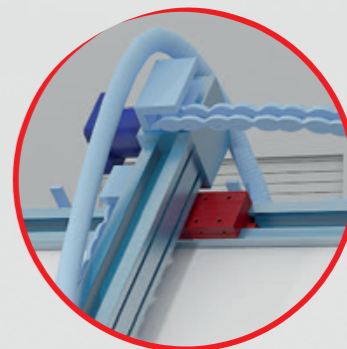

DIE CUTTING MACHINE

> Porte d'ouverture pour machine-outil
Machine tool opening door

> Septième axe pour le chargement/déchargement de machines-outils
Seventh axis for machines loading and unloading

> Septième axe pour l'alimentation de presses
Seventh axis for press loading and unloading

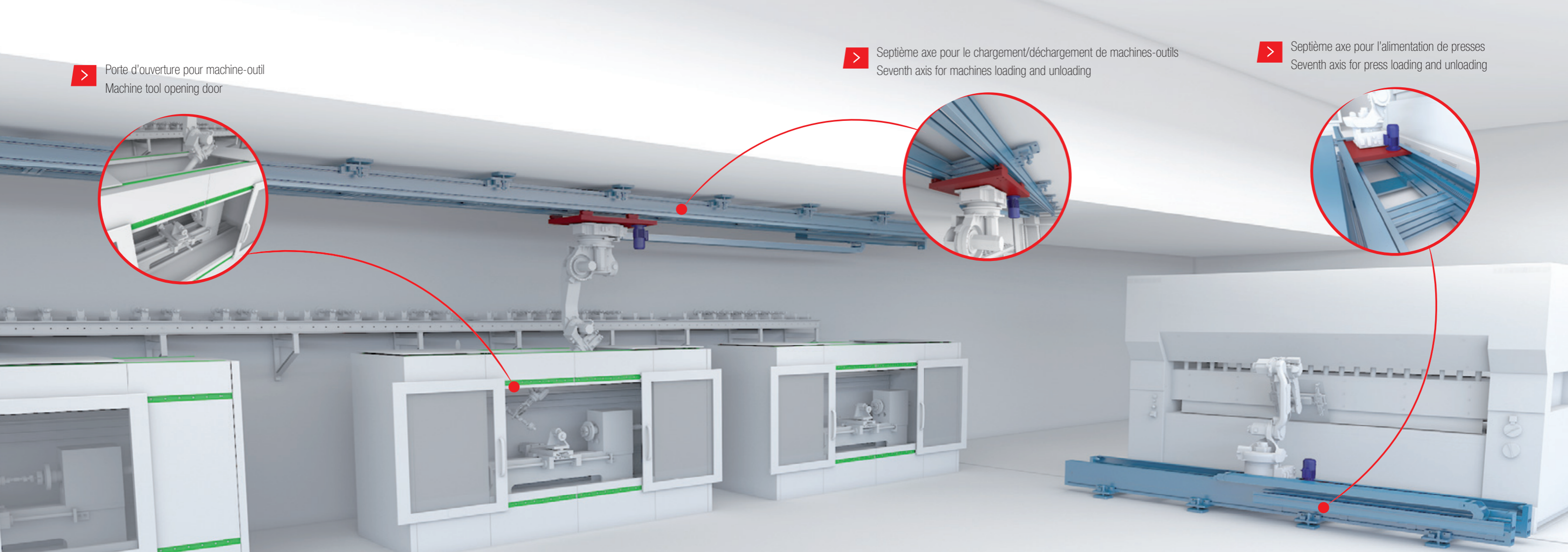

> Septième axe pour robot d'encollage
Seventh axis for gluing robot

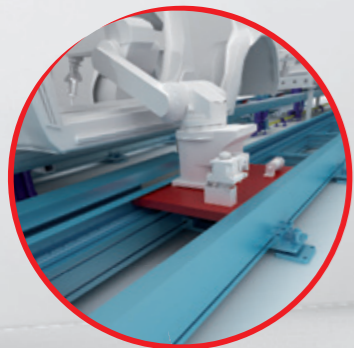

> Axe Z pour système "lift and move"
Z axis of lift and move system

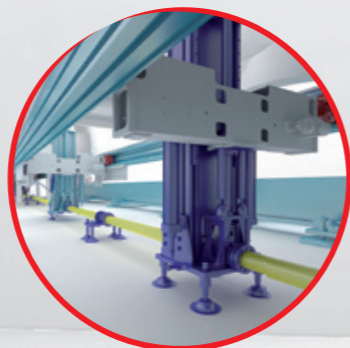

> Septième axe pour robot de peinture
Seventh axis for painting robot

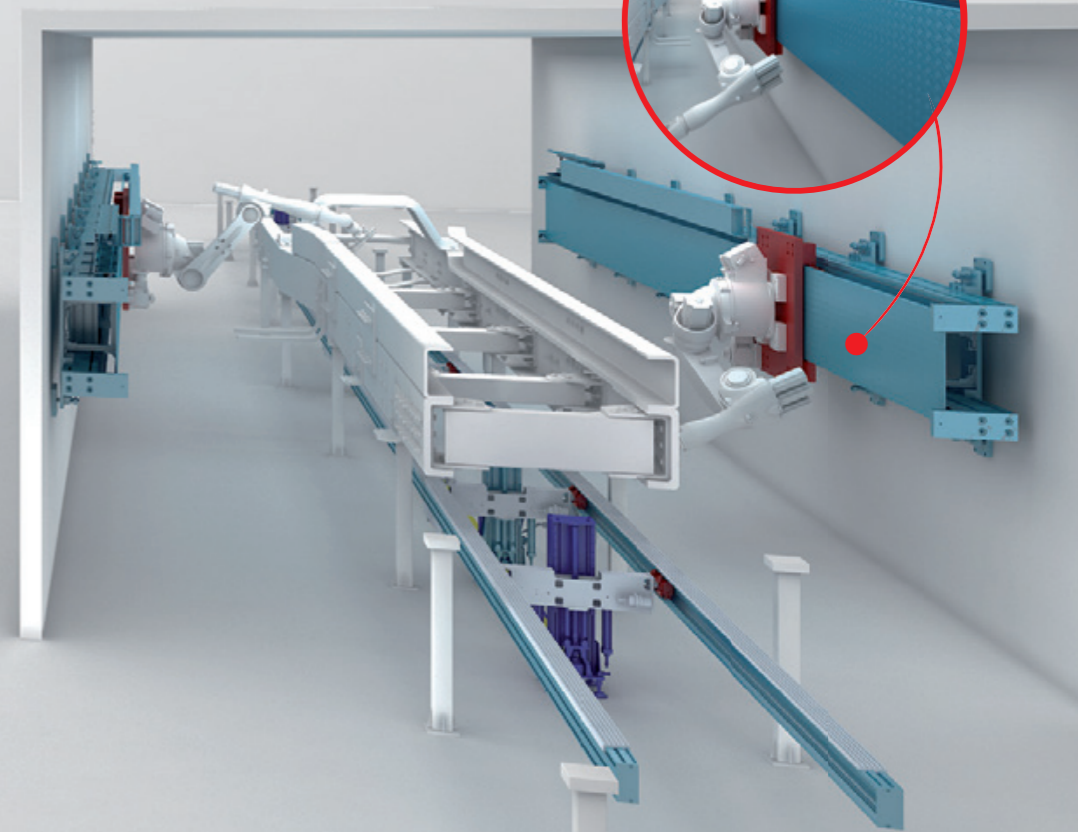
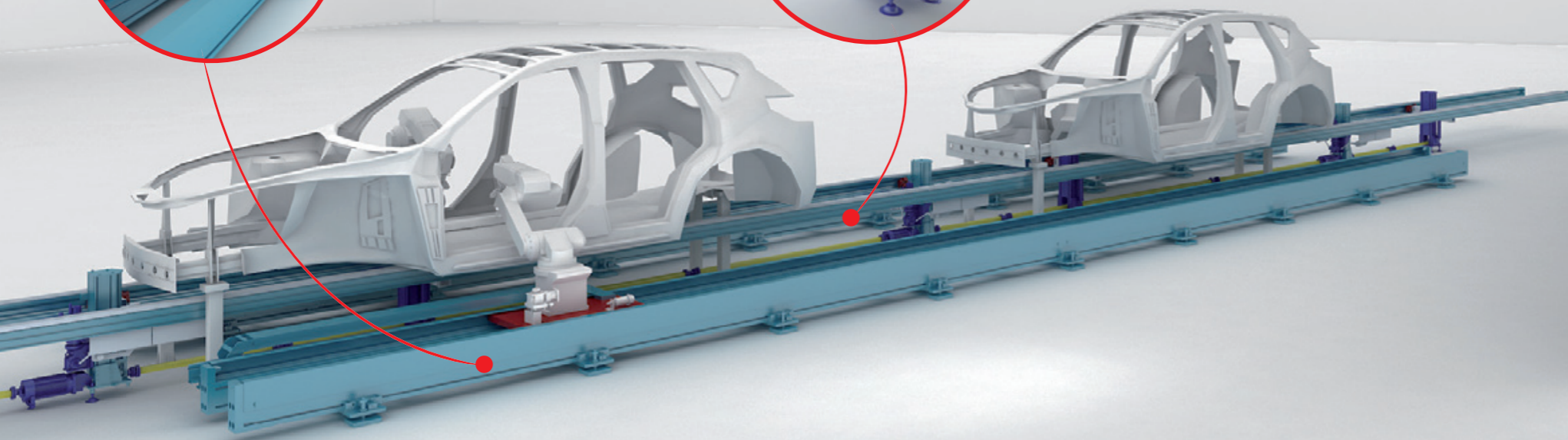
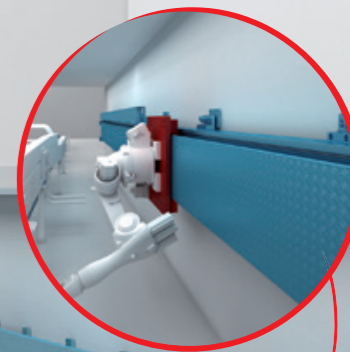

> Axes X-Y pour machines de travail de la céramique
X-Y axes of ceramic working machine

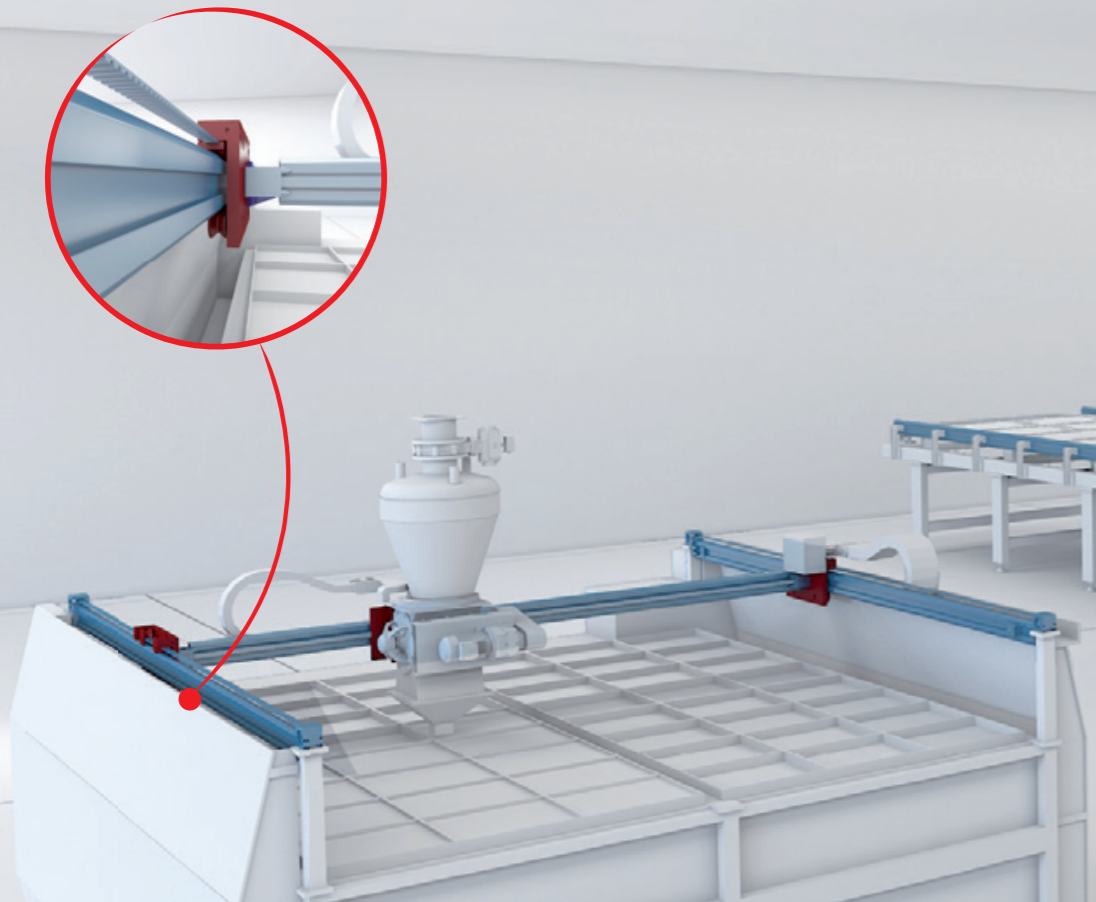

> Chargement et déchargement de machines pour le travail du bois
Loading and unloading of wood working machine

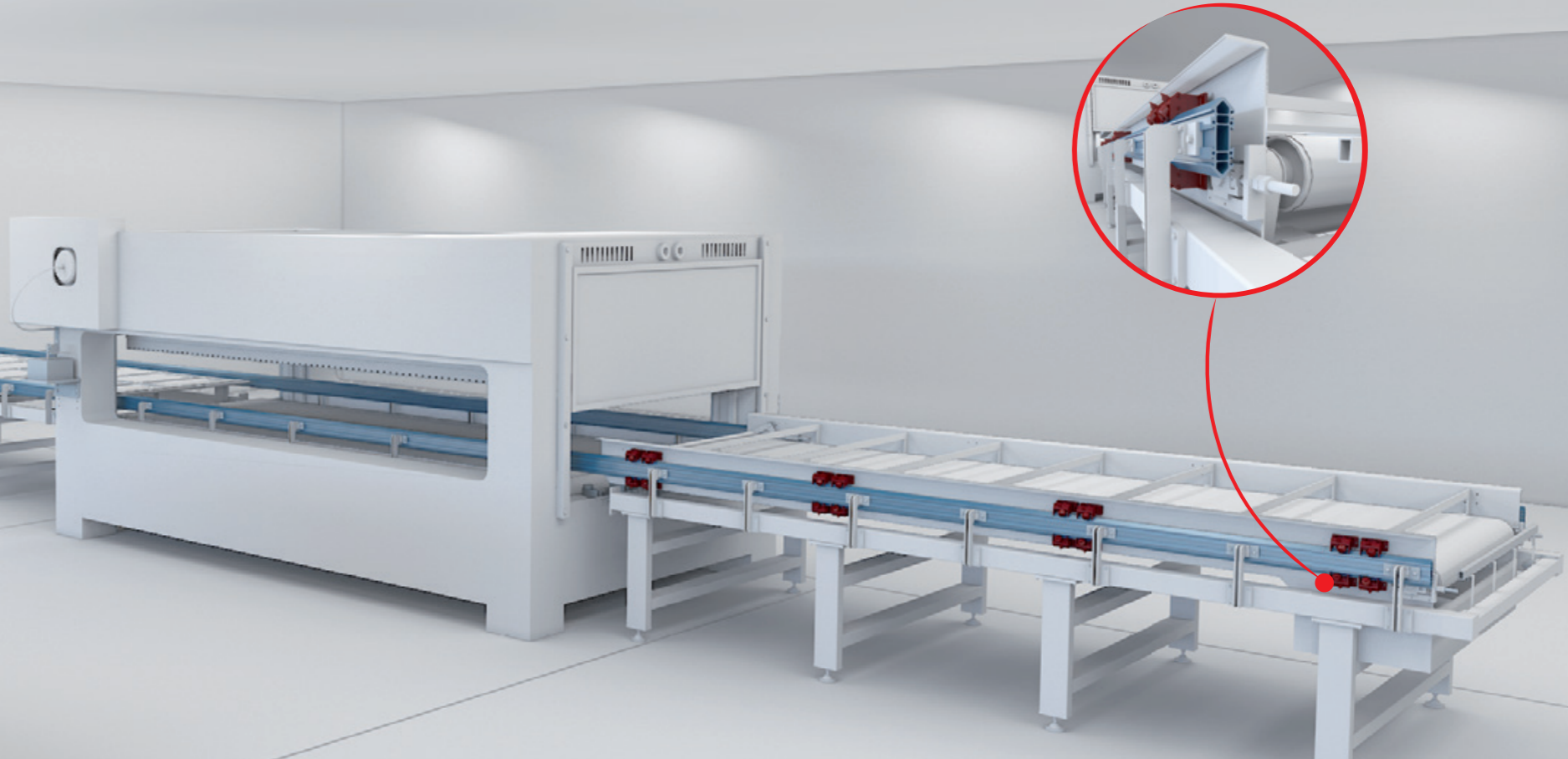

> Soudage de treillis métallique
Wire mesh welding

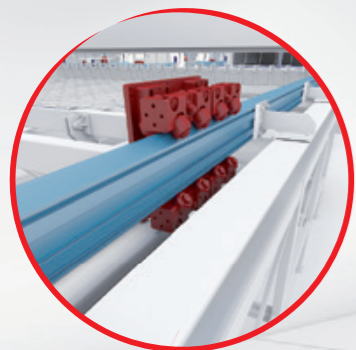

> Soudage de treillis métallique
Wire mesh welding

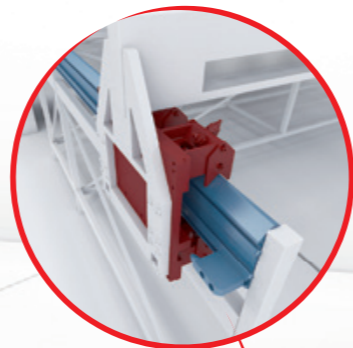

> Axes X-Y pour machines de chargement et déchargement de pièces usinées
X-Y axes of loading and unloading of machined pieces

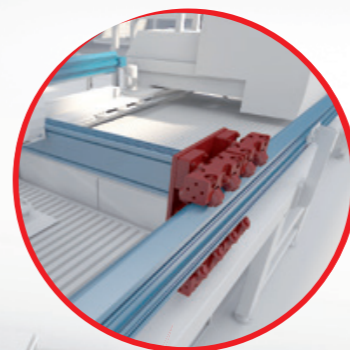

> Axe Z pour machines de chargement et déchargement de pièces usinées
Z axis of loading and unloading of machined pieces

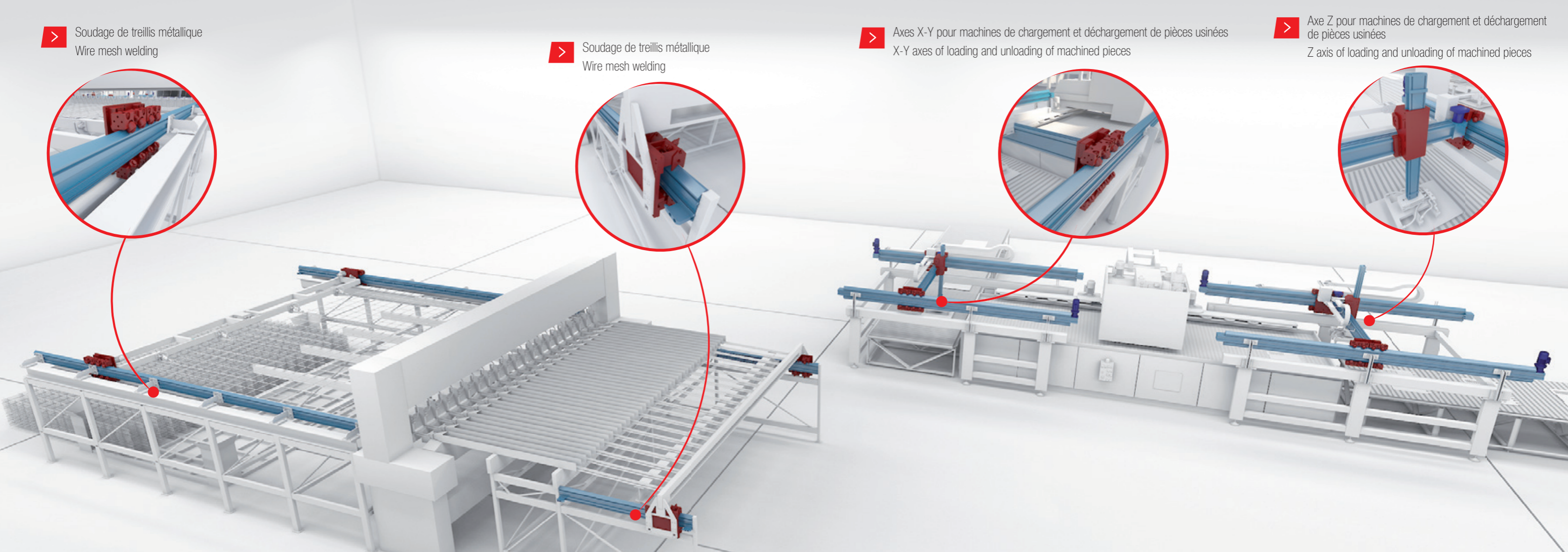
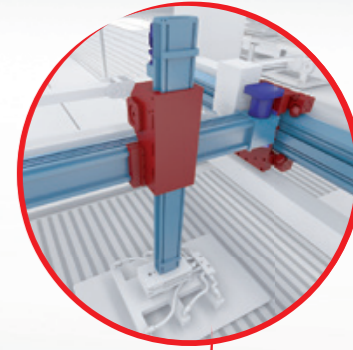

> Machines pour la peinture
Painting machines

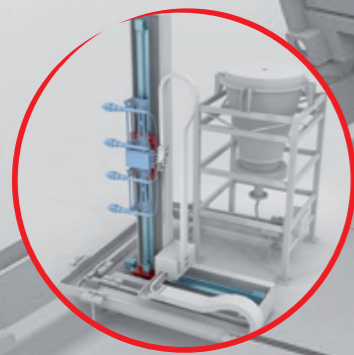

> Septième axe pour robot de soudage
Seventh axis for welding robot

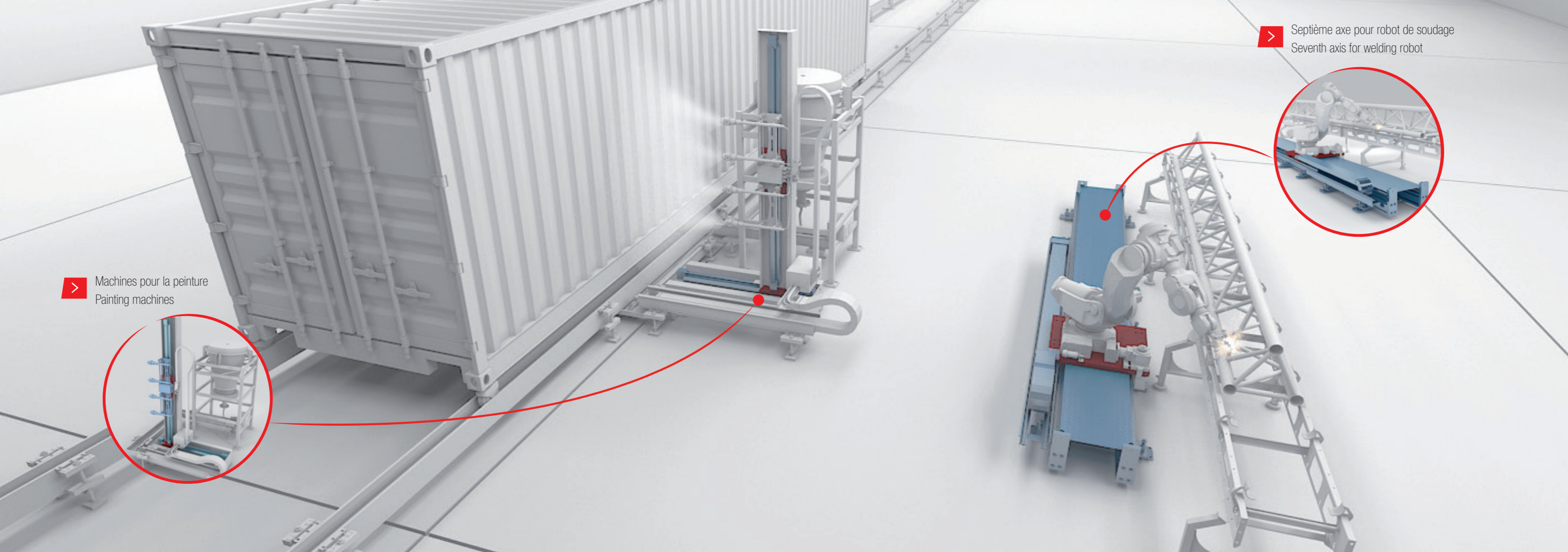
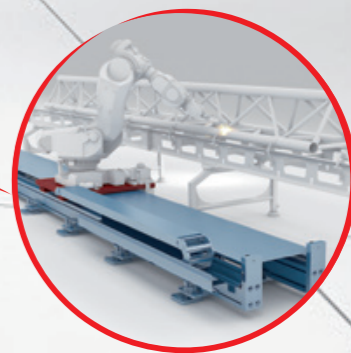



Guidages linéaires et courbes à billes et à galets.
Linear and curved guides with ball and roller bearings.

Linear Line

Telescopic Line

Glissières télescopiques à billes
Telescopic guides with ball bearings

Une gamme complète pour le mouvement linéaire qui satisfait chaque client

A complete range for linear motion which reaches every customer

Fournisseur mondial de solutions linéaires
A global provider of solutions for applications for linear motion

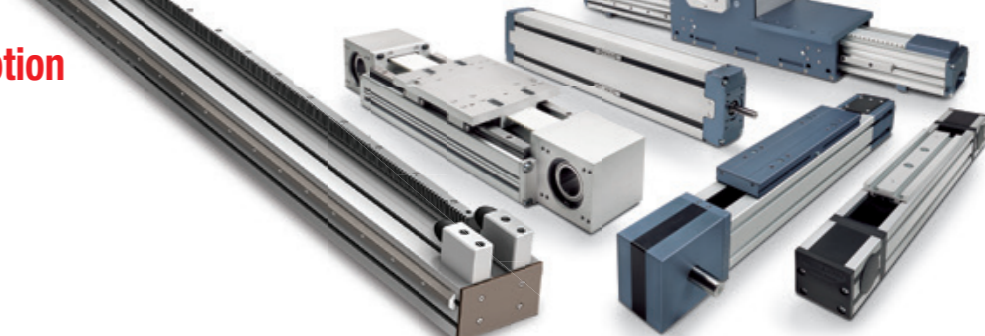

Axes linéaires avec différents types de guidage et différents modes d'entraînement.
Linear actuators with different guide configurations and drives.

Actuator Line



Actuator System Line

Systèmes spéciaux multi-axes pour l'automatisation industrielle.
Special multiple axis systems for industrial automation.

Solutions linéaires pour toutes applications Linear solutions for every application

Notes • Notes

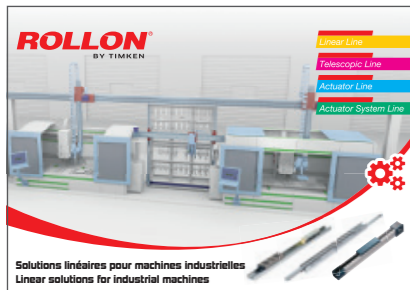



● Filiales et bureaux commerciaux ● Distributeurs

EUROPE

ROLLON S.p.A. - ITALY (Headquarters)

Via Trieste 26
I-20871 Vimercate (MB)
Phone: (+39) 039 62 59 1
www.rollon.it - infocom@rollon.it

ROLLON GmbH - GERMANY

Bonner Strasse 317-319
D-40589 Düsseldorf
Phone: (+49) 211 95 747 0
www.rollon.de - info@rollon.de

ROLLON S.A.R.L. - FRANCE

Les Jardins d'Eole, 2 allée des Séquoias
F-69760 Limonest
Phone: (+33) (0) 4 74 71 93 30
www.rollon.fr - infocom@rollon.fr

ROLLON B.V. - NETHERLANDS

Ringbaan Zuid 8
6905 DB Zevenaar
Phone: (+31) 316 581 999
www.rollon.nl - info@rollon.nl

ROLLON S.p.A. - RUSSIA (Rep. Office)

117105, Moscow, Varshavskoye
shosse 17, building 1
Phone: +7 (495) 508-10-70
www.rollon.ru - info@rollon.ru

ROLLON Ltd - UK (Rep. Office)

The Works 6 West Street Olney
Buckinghamshire, United Kingdom, MK46 5 HR
Phone: +44 (0) 1234964024
www.rollon.uk.com - info@rollon.uk.com

AMERICA

ROLLON Corporation - USA

101 Bilby Road, Suite B
Hackettstown, NJ 07840
Phone: (+1) 973 300 5492
www.rolloncorp.com - info@rolloncorp.com

ROLLON - SOUTH AMERICA (Rep. Office)

R. Joaquim Floriano, 397, 2o. andar
Itaim Bibi - 04534-011, São Paulo, BRASIL
Phone: +55 (11) 3198 3645
www.rollonbrasil.com.br - info@rollonbrasil.com

ASIA

ROLLON Ltd - CHINA

No. 1155 Pang Jin Road,
China, Suzhou, 215200
Phone: +86 0512 6392 1625
www.rollon.cn.com - info@rollon.cn.com

ROLLON India Pvt. Ltd. - INDIA

1st floor, Regus Gem Business Centre, 26/1
Hosur Road, Bommanahalli, Bangalore 560068
Phone: (+91) 80 67027066
www.rollonindia.in - info@rollonindia.in

ROLLON - JAPAN

3F Shiodome Building, 1-2-20 Kaigan, Minato-ku,
Tokyo 105-0022 Japan
Phone +81 3 6721 8487
www.rollon.jp - info@rollon.jp